

ATLIÉR NAVRHOVANIA VII, modul M6
NOVÁ NOBELOVKA

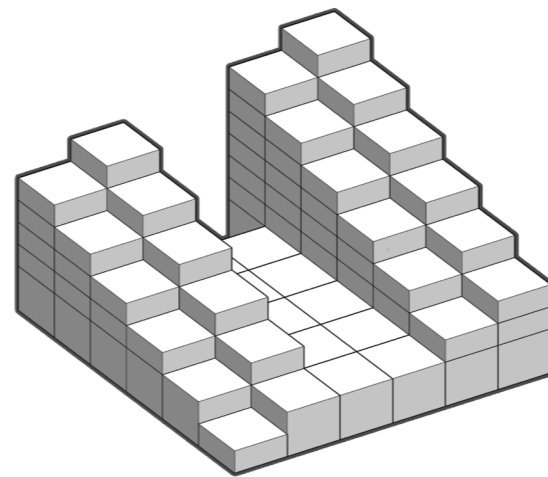

Študent: Michal Križo

Vertikálny ateliér: a:za - Ateliér zelenej architektúry

Vedúci práce: doc. Ing. arch. Henrich Pifko, CSc.

Ing. arch. Klára Macháčová, PhD.



Ing. arch. Lorant Krajcsovics, PhD.

Garant predmetu: doc. Ing. arch. Henrich Pifko, CSc.

Akademický rok: ZS 2020/2021 Dátum: 13.1.2021

ŠIRŠIE VZŤAHY

LEGENDA

-  Nová Nobelovka
-  Železničná trať
-  Hlavný dopravný ťah - Račianska ulica



1000 m





SITUÁCIA M_1:500

LEGENDA

- Hranica pozemku
- Navrhovaná cyklotrasa
- A** Časť A - Pasáž, prestrešená píllovou strechou
- B** Časť B
- C** Časť C
- 1.** Ateliér Kusý - Paňák



HMOTOVÝ KONCEPT

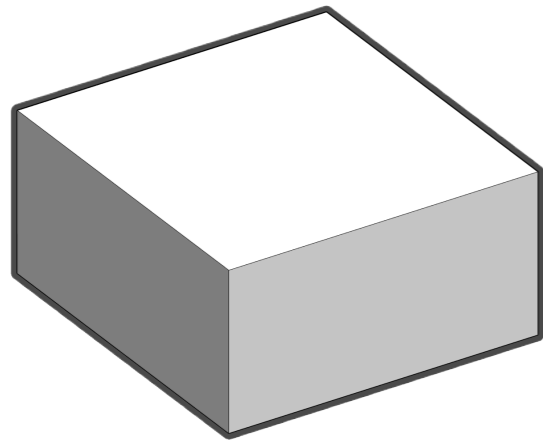

Krok 1

Základná hmota budovy

HMOTOVÝ KONCEPT

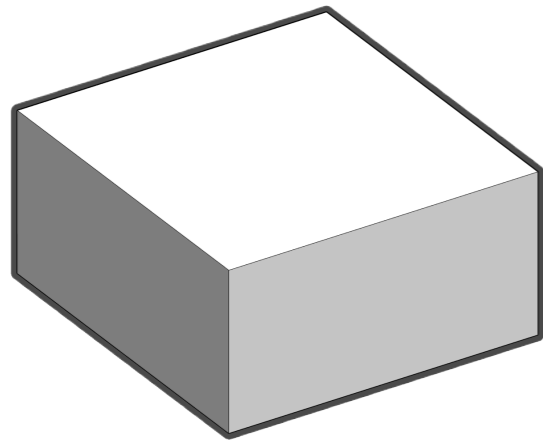

Krok 1
Základná hmota budovy

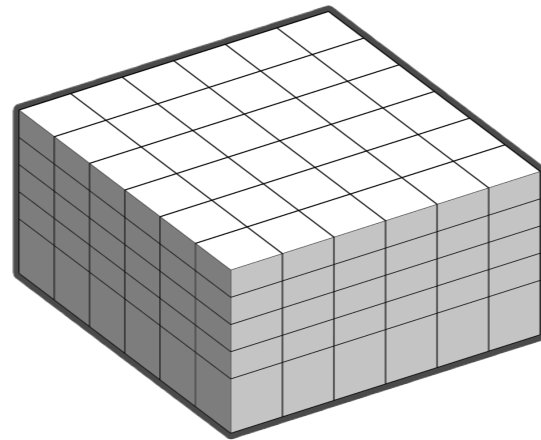

Krok 2
Rozdelenie na konštrukčný modul

HMOTOVÝ KONCEPT

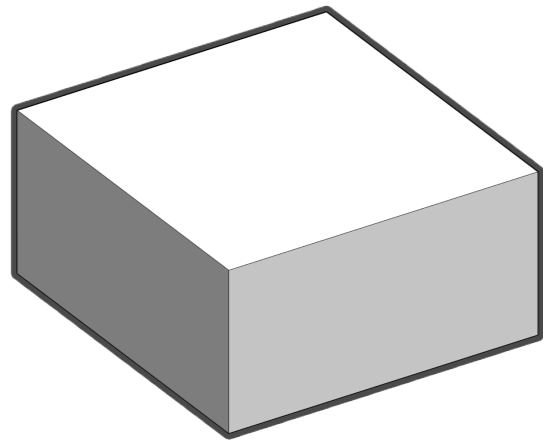

Krok 1
Základná hmota budovy

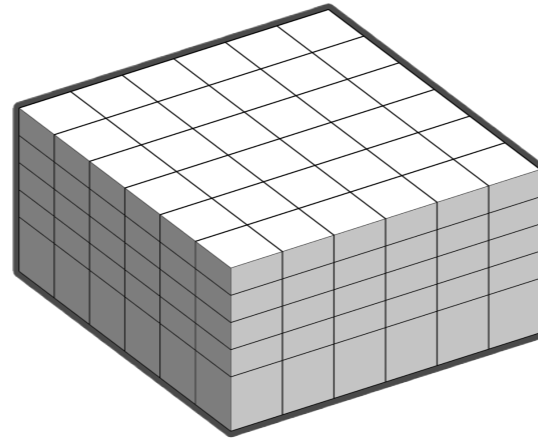

Krok 2
Rozdelenie na konštrukčný modul

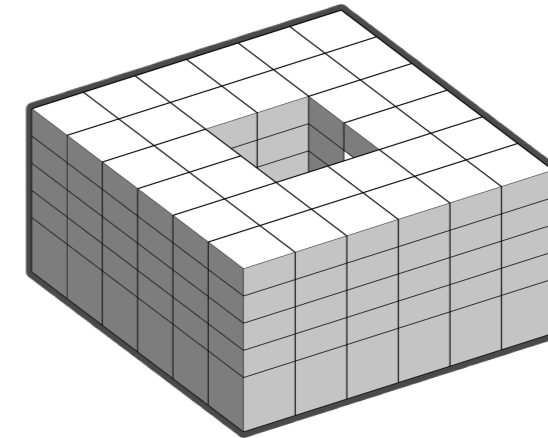

Krok 3
Vytvorenie átria

HMOTOVÝ KONCEPT

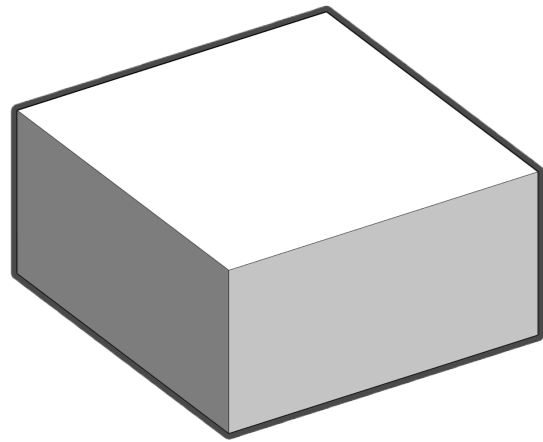

Krok 1
Základná hmota budovy

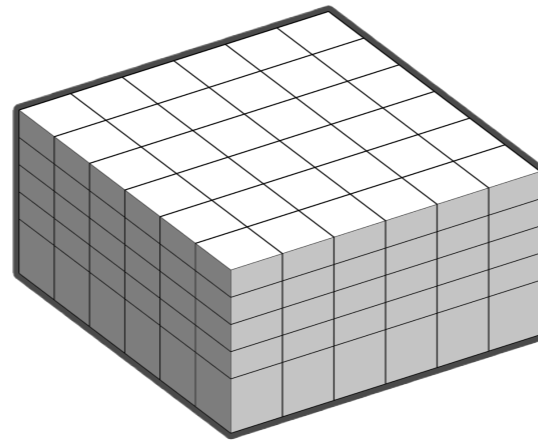

Krok 2
Rozdelenie na konštrukčný modul

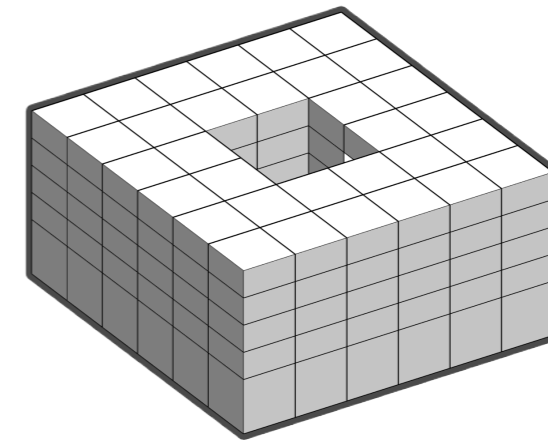

Krok 3
Vytvorenie átria

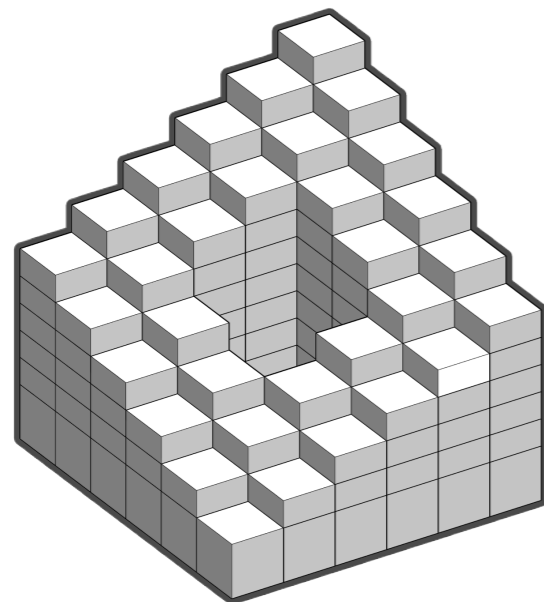

Krok 4
Vytvorenie ustupujúcich terás s
orientáciou na juh

HMOTOVÝ KONCEPT

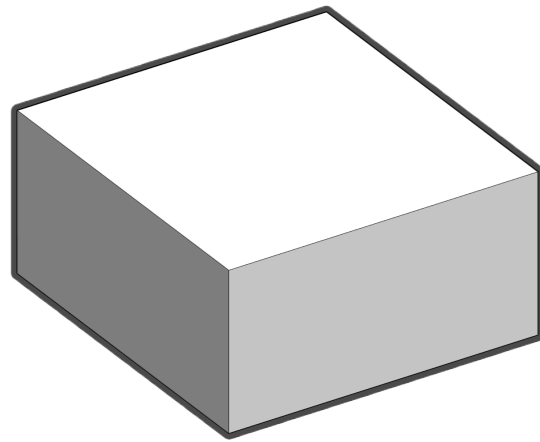

Krok 1
Základná hmota budovy

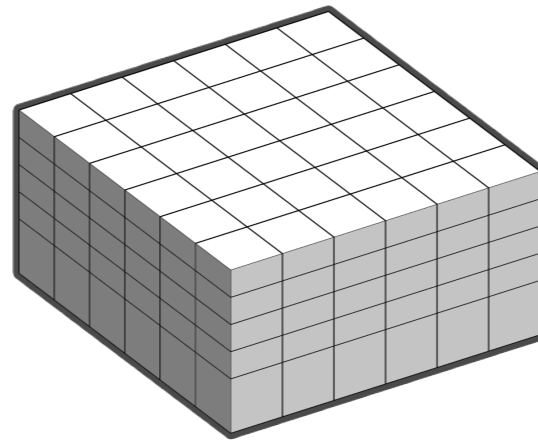

Krok 2
Rozdelenie na konštrukčný modul

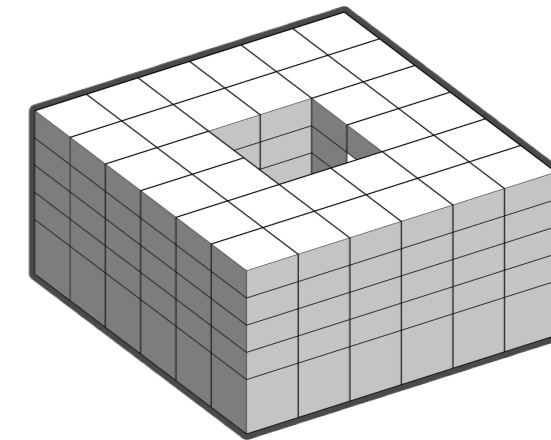

Krok 3
Vytvorenie átria

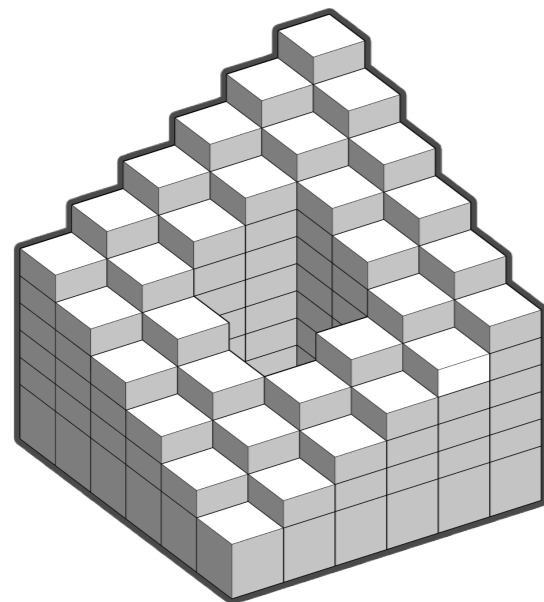

Krok 4
Vytvorenie ustupujúcich terás s orientáciou na juh

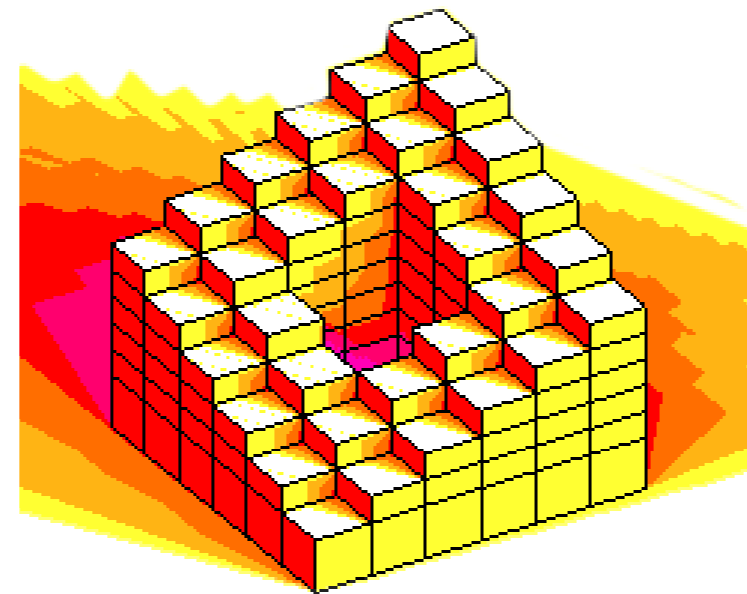

Krok 5
Analýza zatienevia

LEGENDA

Počet hodín zatienevia



HMOTOVÝ KONCEPT

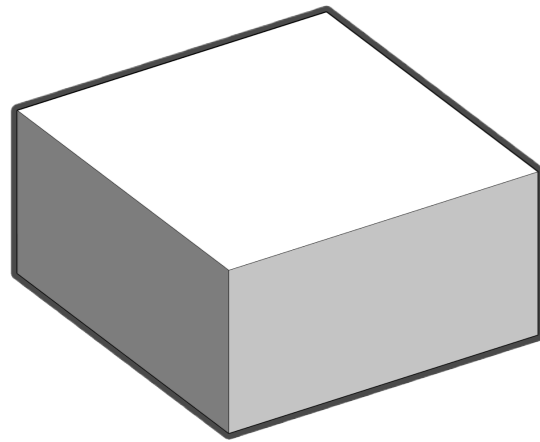

Krok 1
Základná hmota budovy

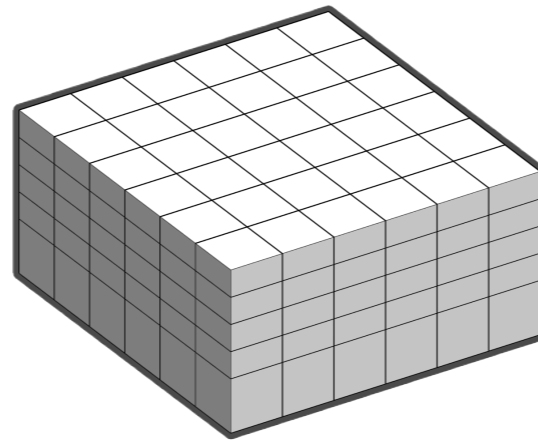

Krok 2
Rozdelenie na konštrukčný modul

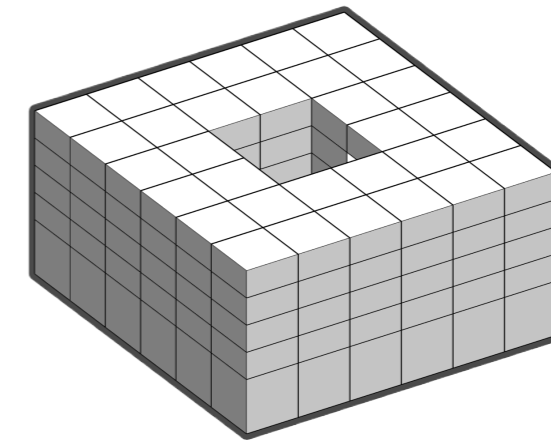

Krok 3
Vytvorenie átria

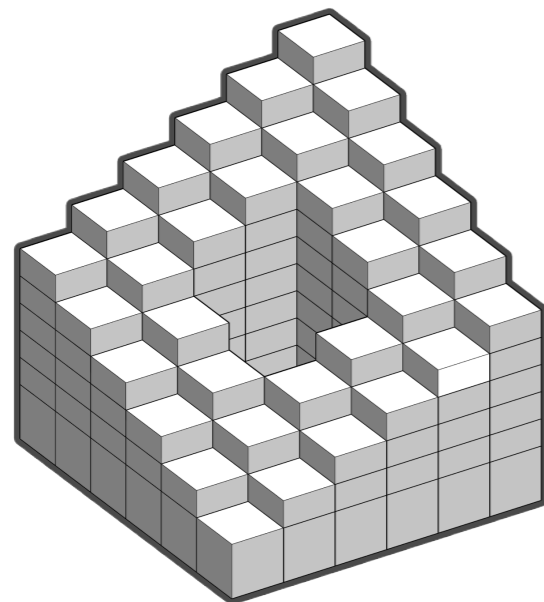

Krok 4
Vytvorenie ustupujúcich terás s orientáciou na juh

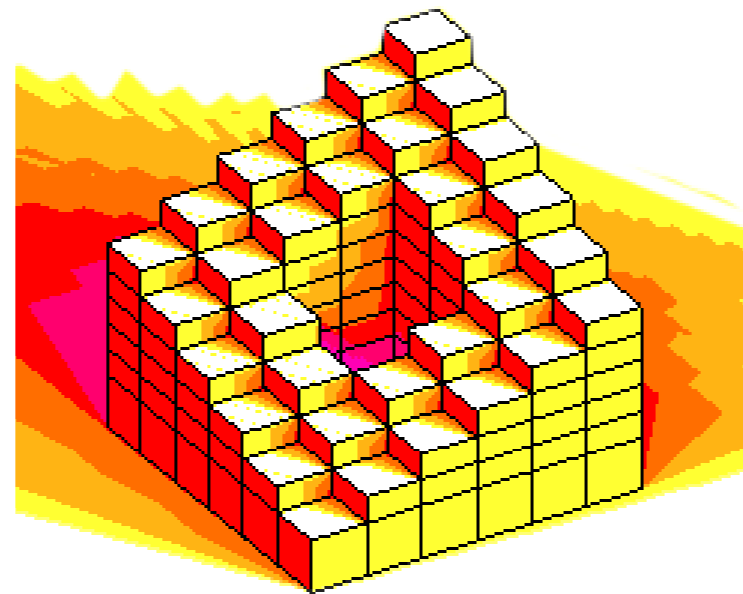

Krok 5
Analýza zatienenia

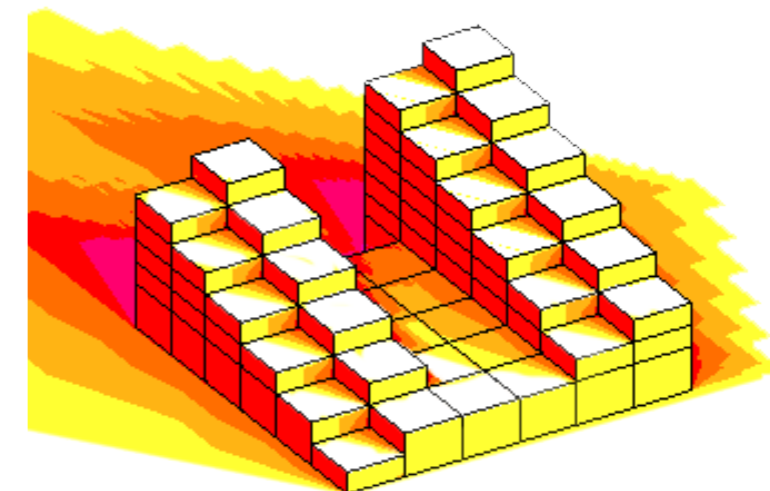

Krok 6
Optimalizácia svetlotechnických podmienok

LEGENDA

Počet hodín zatienenia

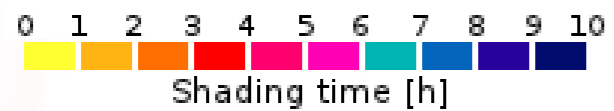

KONCEPT HORIZONTÁLNYCH A VERTIKÁLNYCH KOMUNIKÁCIÍ

NOBELOVA ULICA

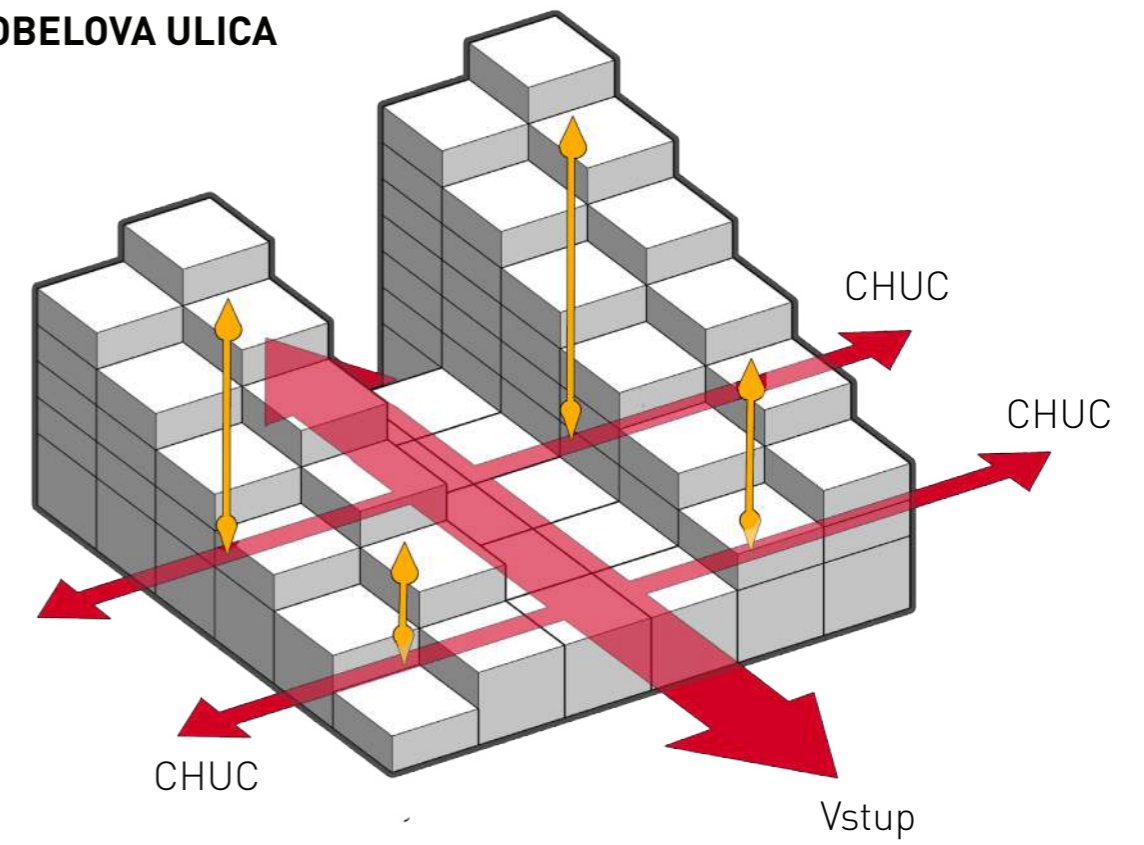

PARK

FUNKČNÝ KONCEPT

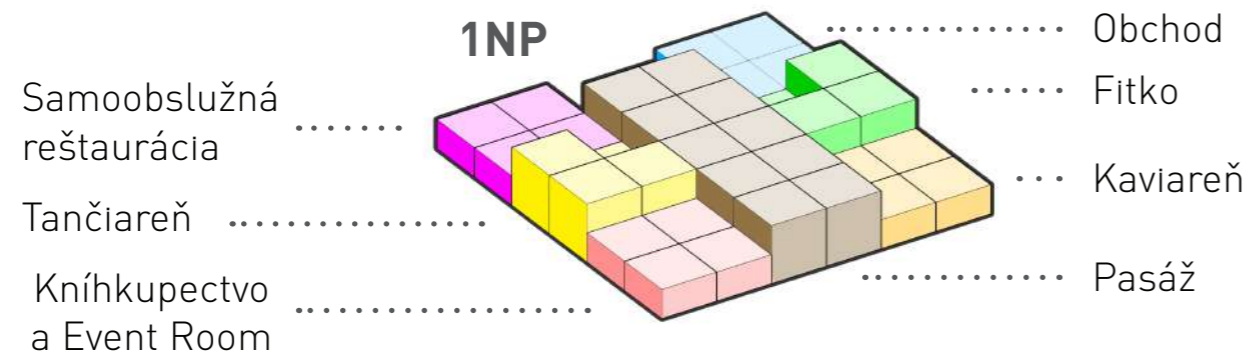

KONCEPT HORIZONTÁLNYCH A VERTIKÁLNYCH KOMUNIKÁCIÍ

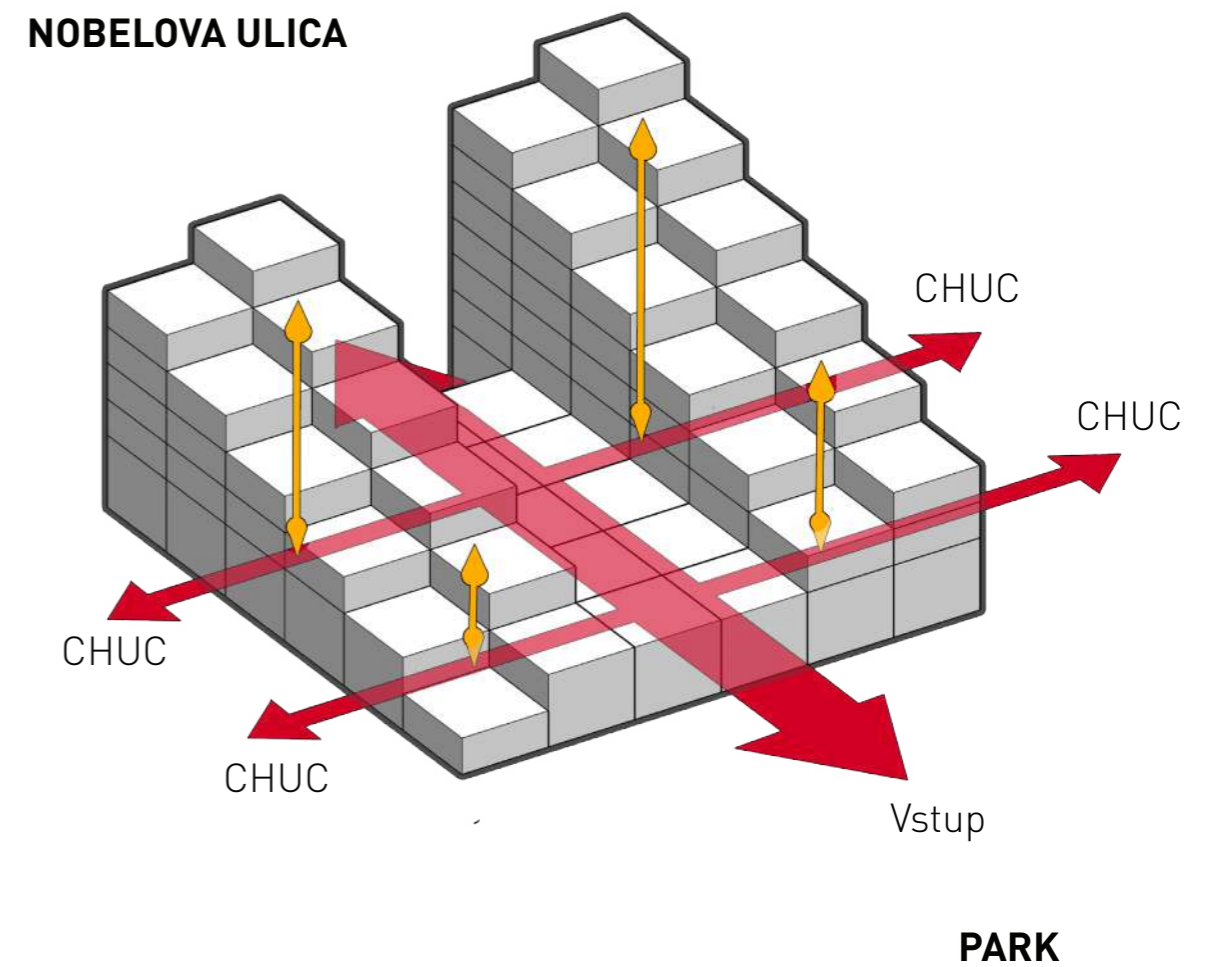

FUNKČNÝ KONCEPT

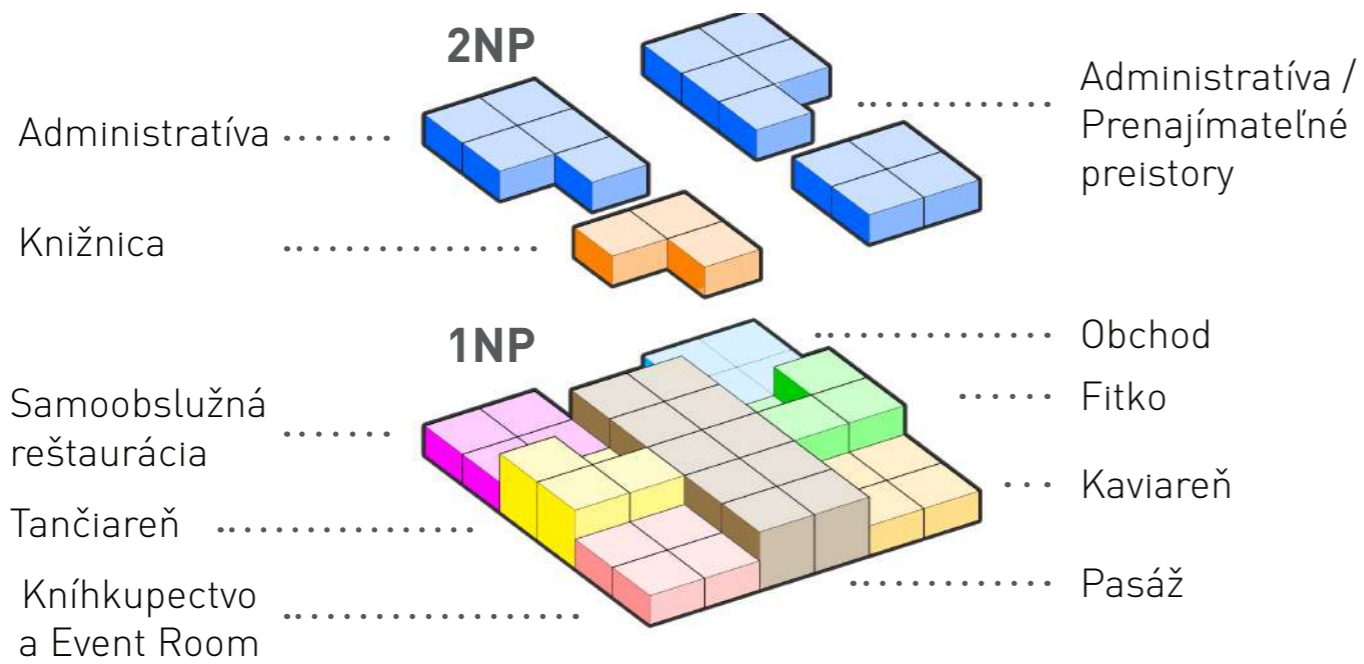

KONCEPT HORIZONTÁLNYCH A VERTIKÁLNYCH KOMUNIKÁCIÍ

NOBELOVA ULICA

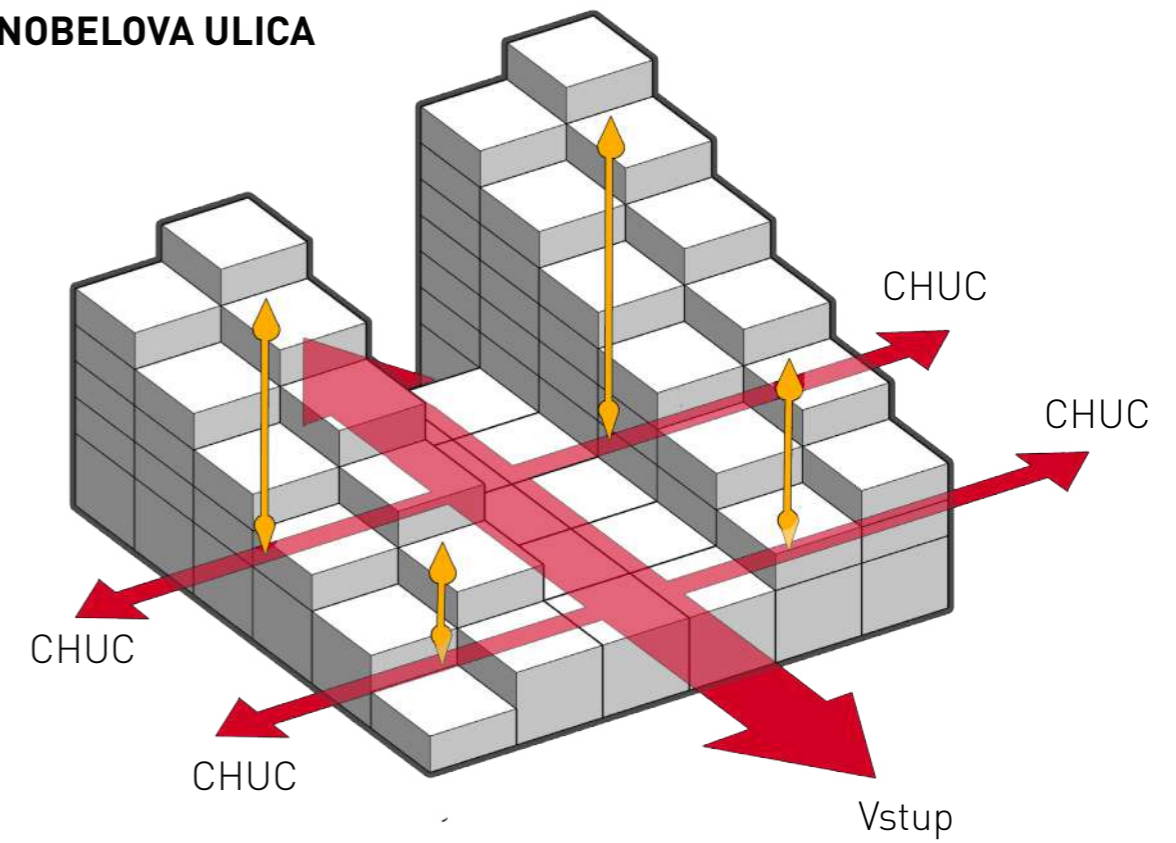

FUNKČNÝ KONCEPT

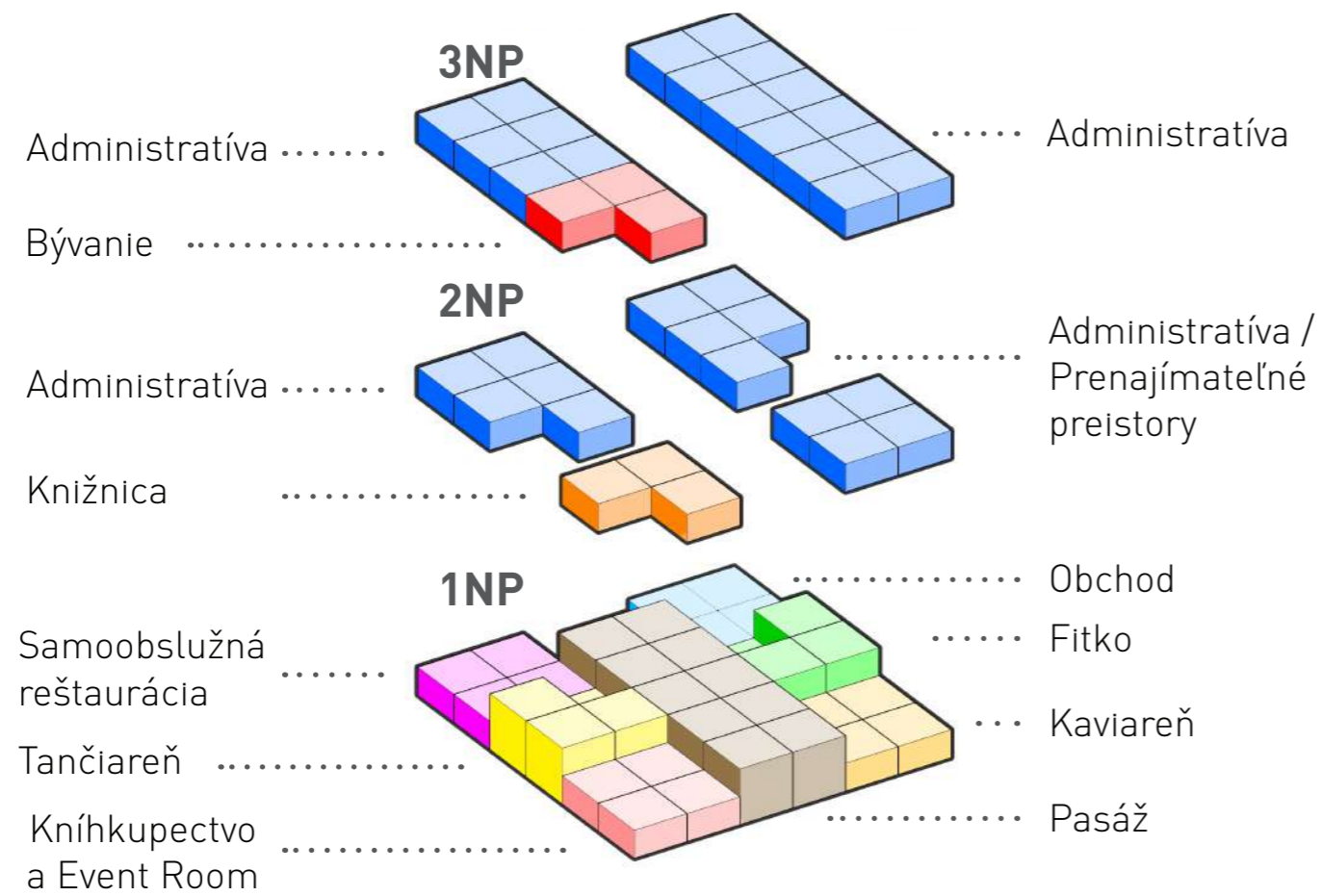

KONCEPT HORIZONTÁLNYCH A VERTIKÁLNYCH KOMUNIKÁCIÍ

NOBELOVA ULICA

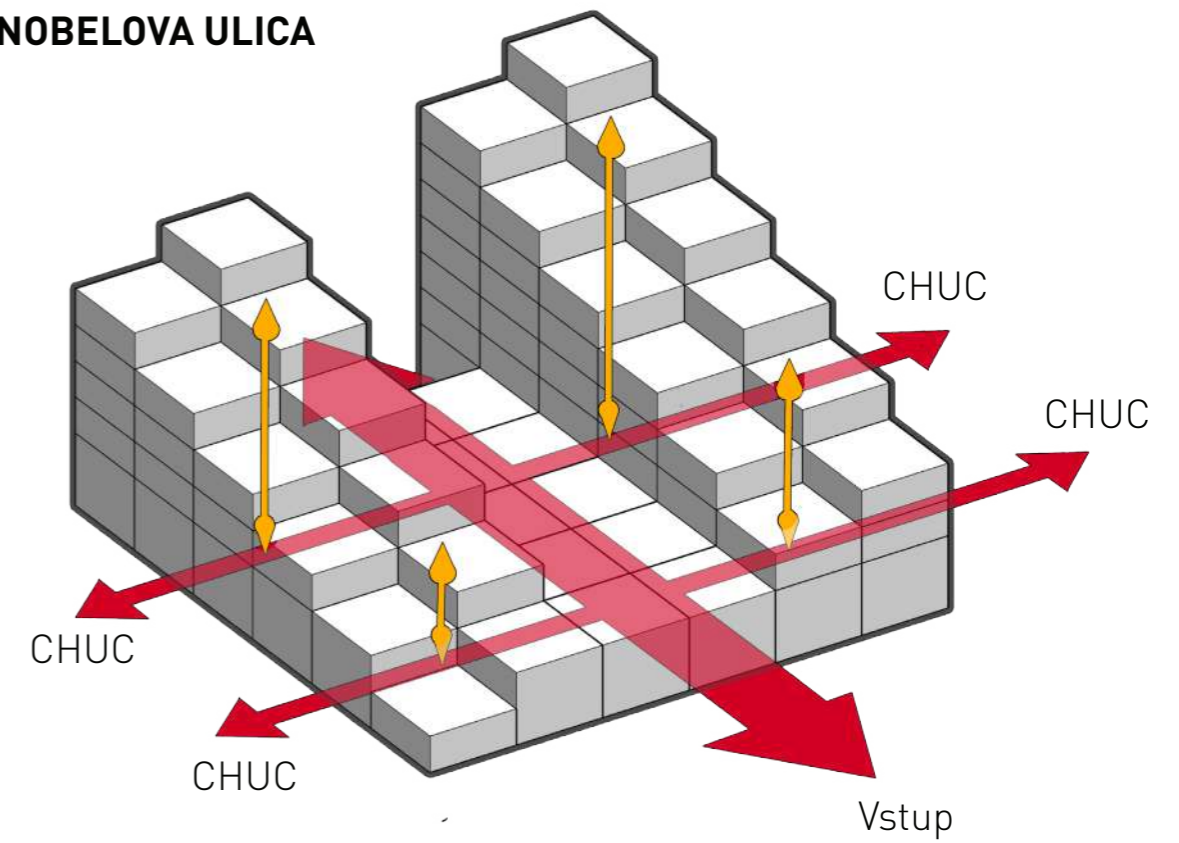

PARK

FUNKČNÝ KONCEPT

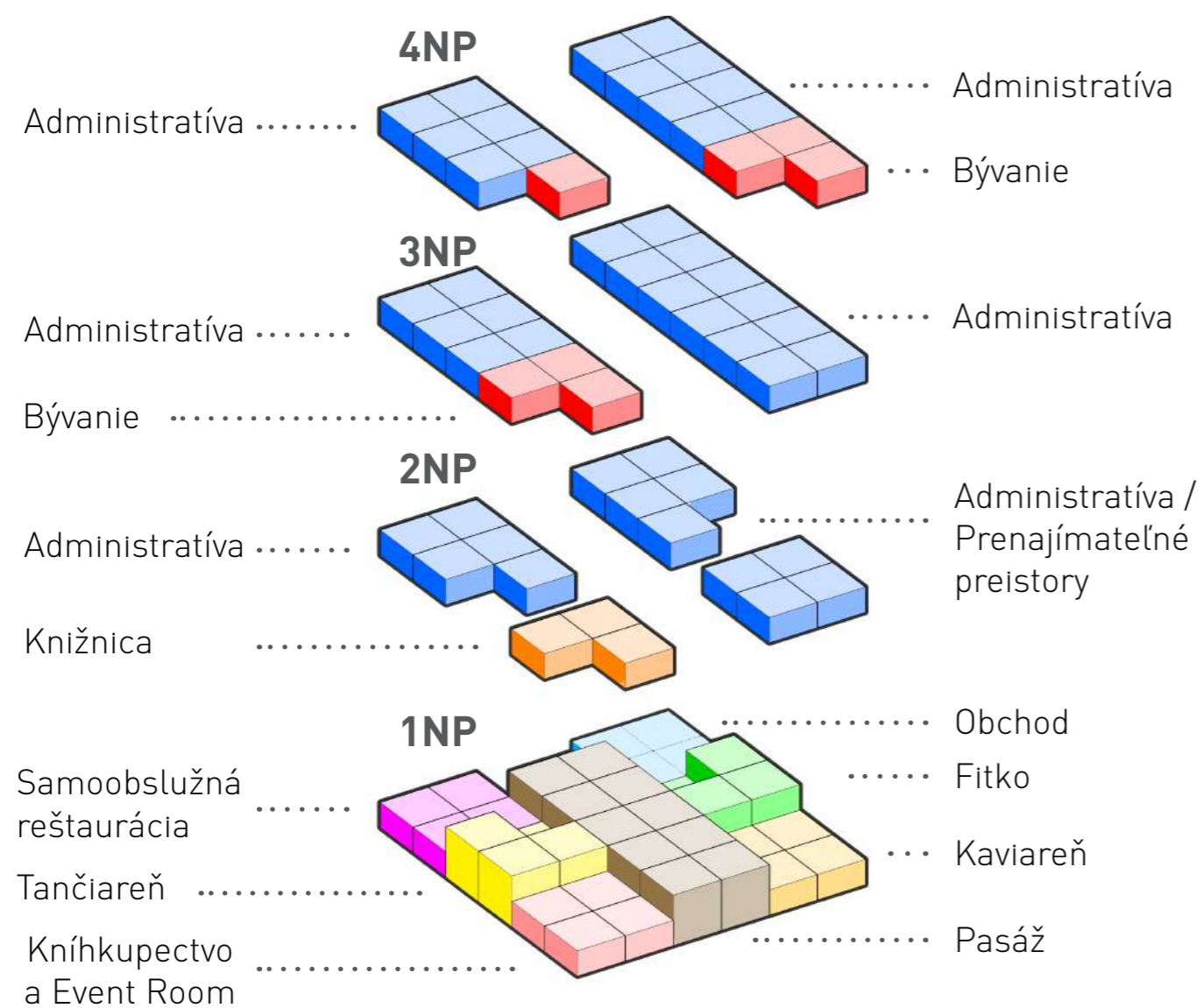

KONCEPT HORIZONTÁLNYCH A VERTIKÁLNYCH KOMUNIKÁCIÍ

NOBELOVA ULICA

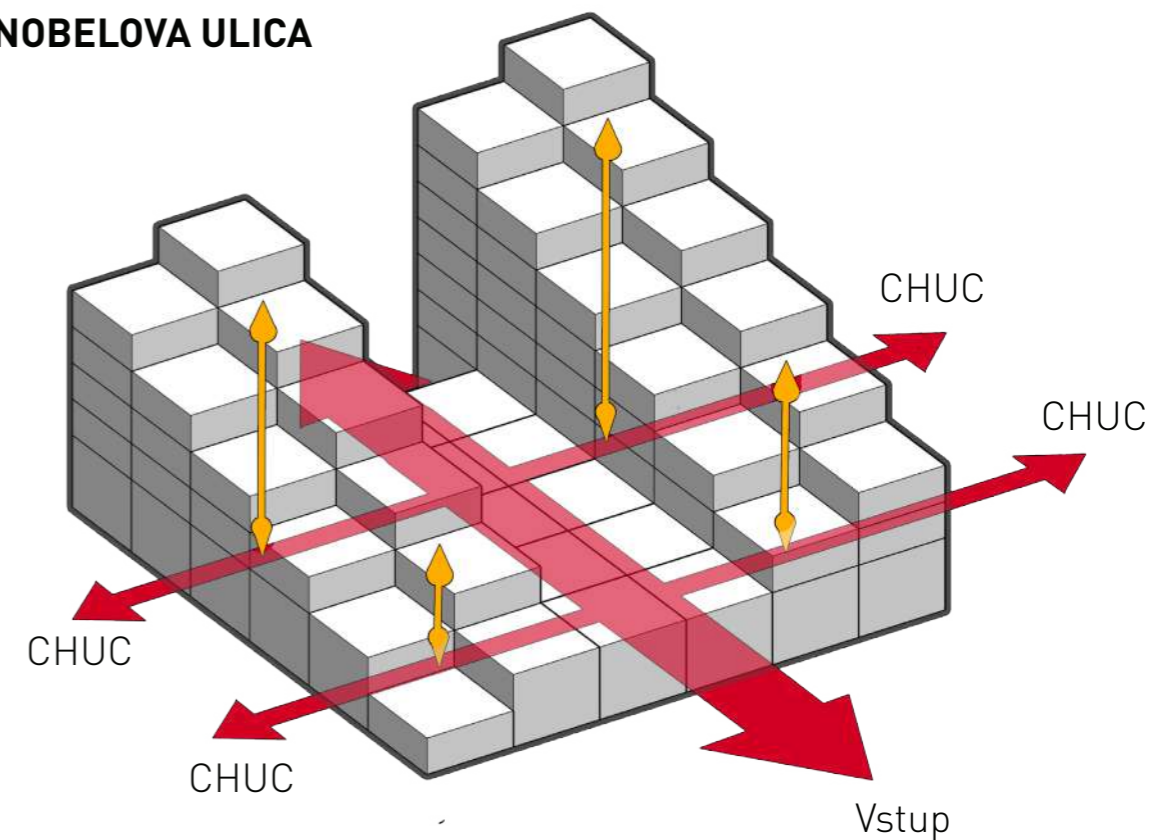

PARK

FUNKČNÝ KONCEPT

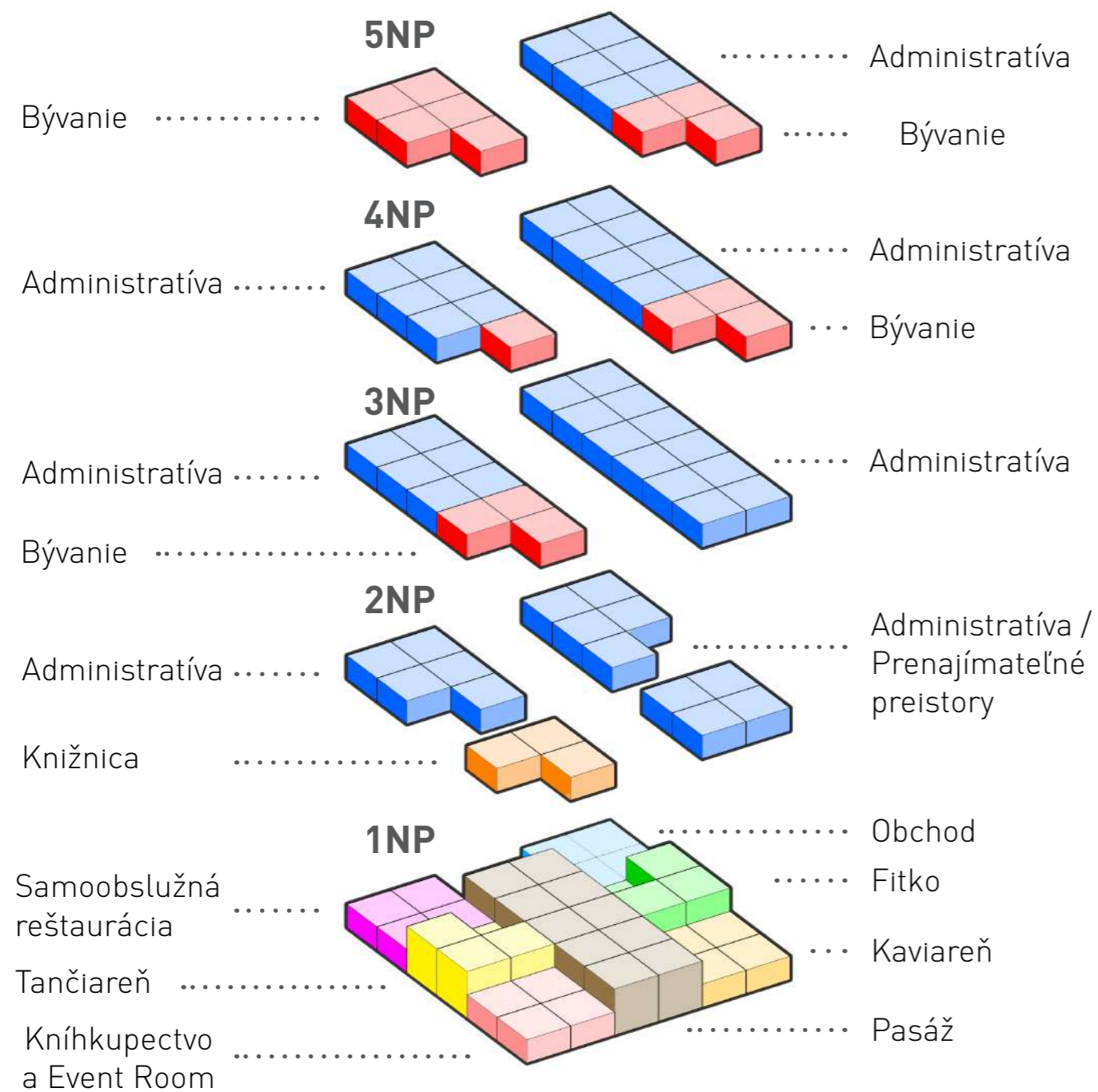

KONCEPT HORIZONTÁLNYCH A VERTIKÁLNYCH KOMUNIKÁCIÍ

NOBELOVA ULICA

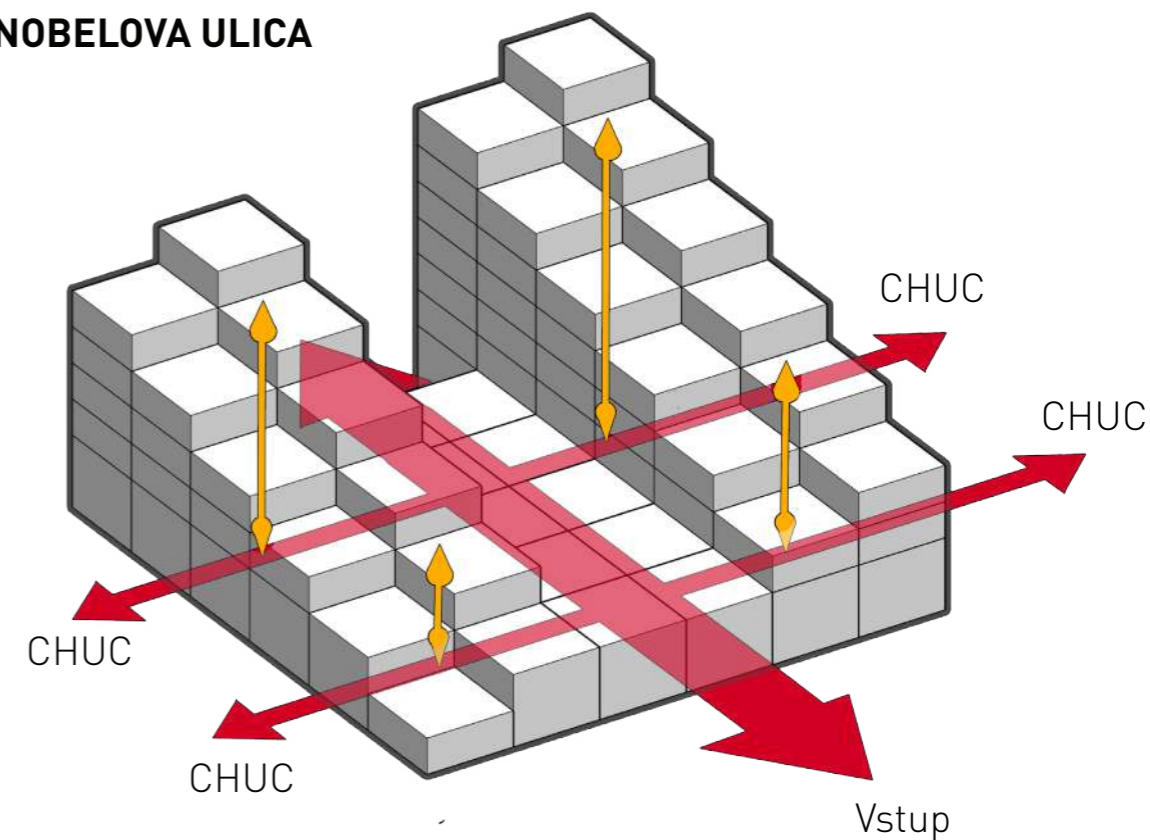

FUNKČNÝ KONCEPT

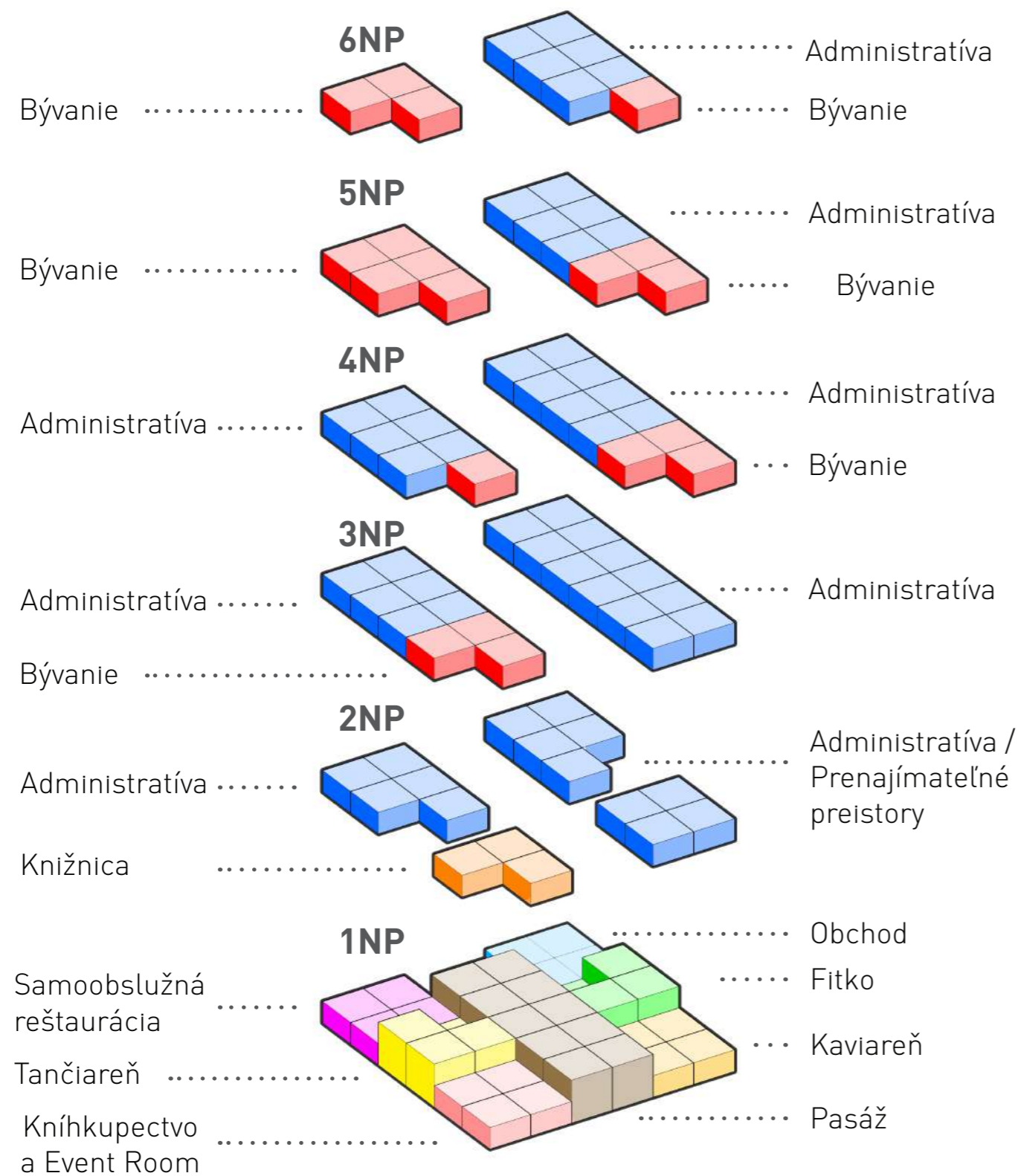

KONCEPT HORIZONTÁLNYCH A VERTIKÁLNYCH KOMUNIKÁCIÍ

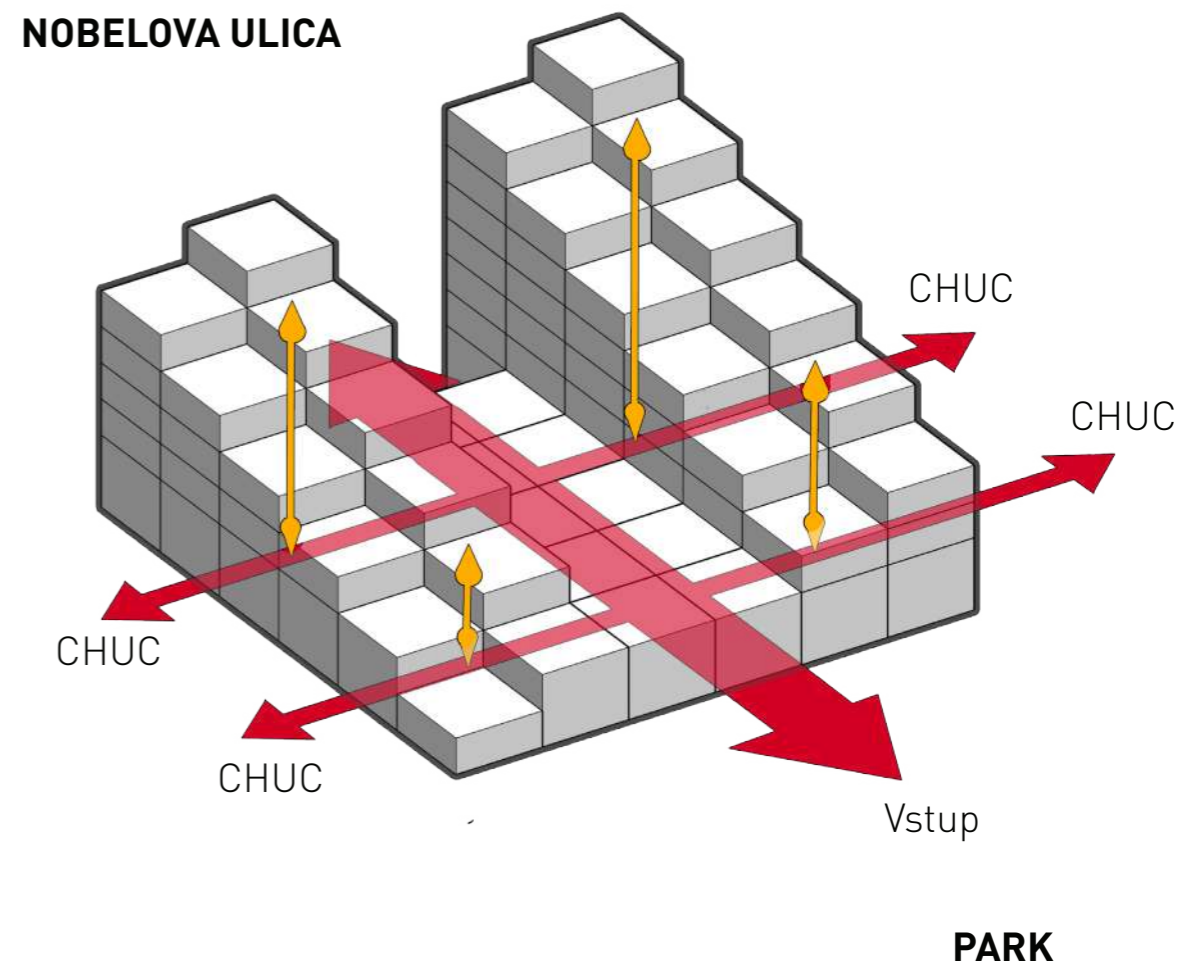

FUNKČNÝ KONCEPT

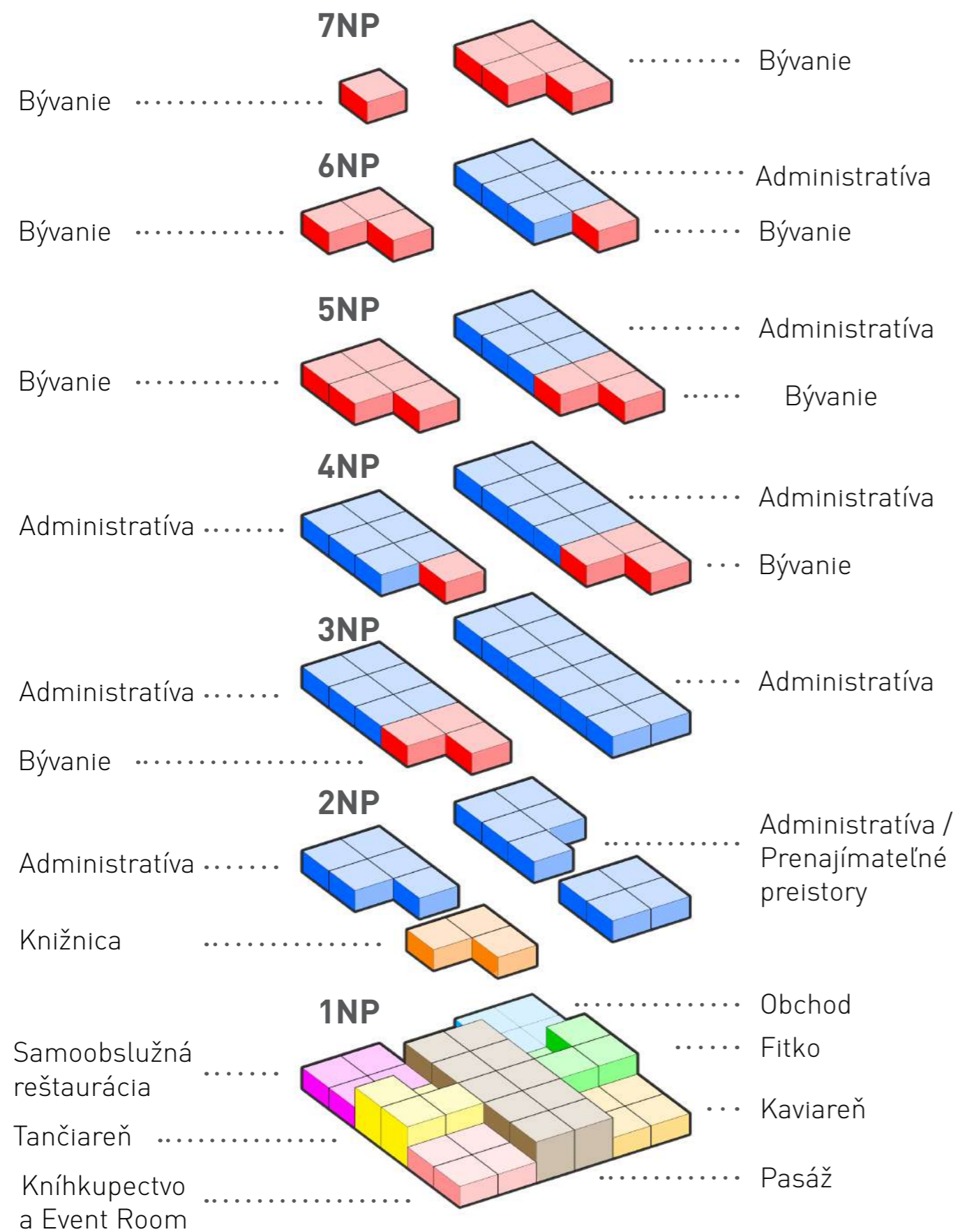

KONCEPT HORIZONTÁLNYCH A VERTIKÁLNYCH KOMUNIKÁCIÍ

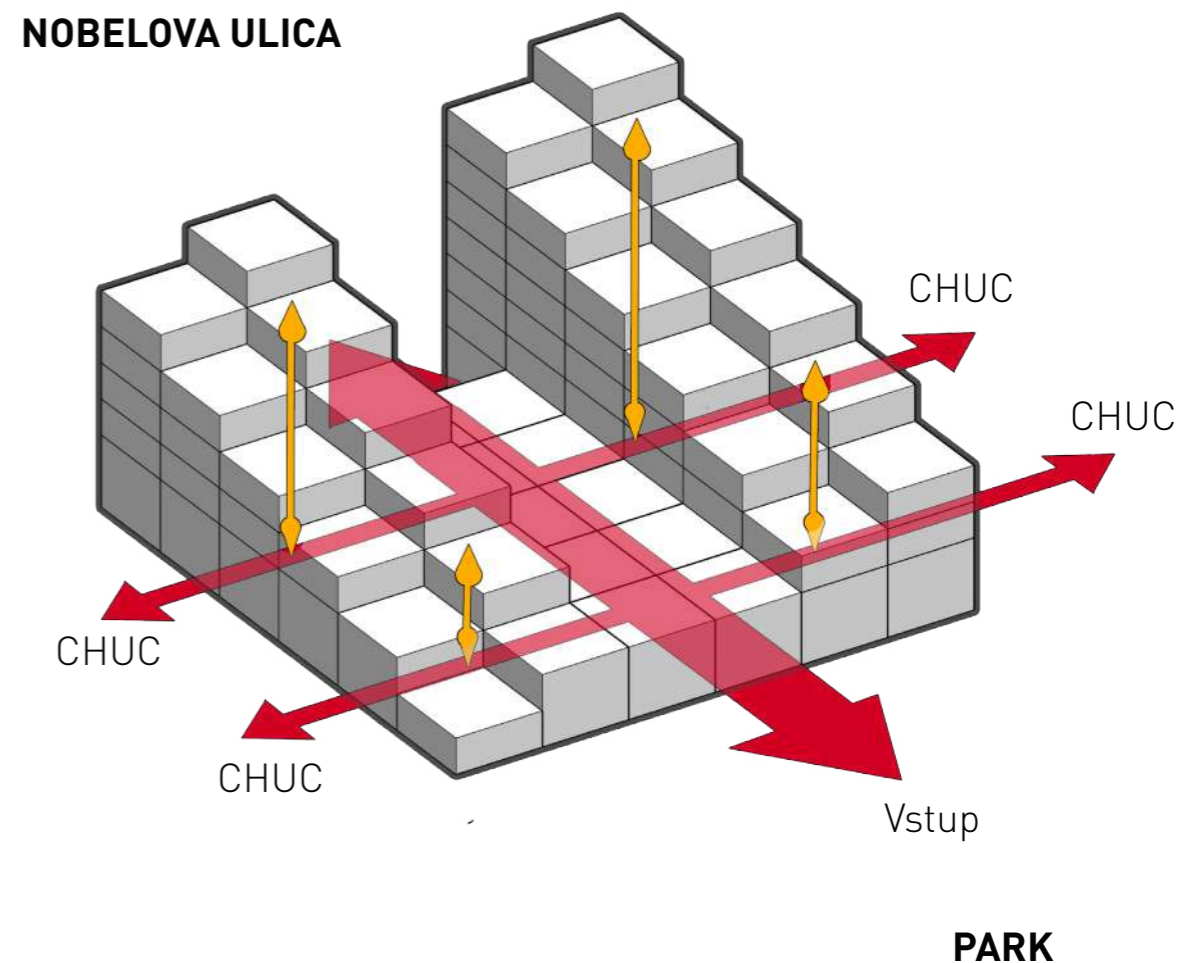

FUNKČNÝ KONCEPT

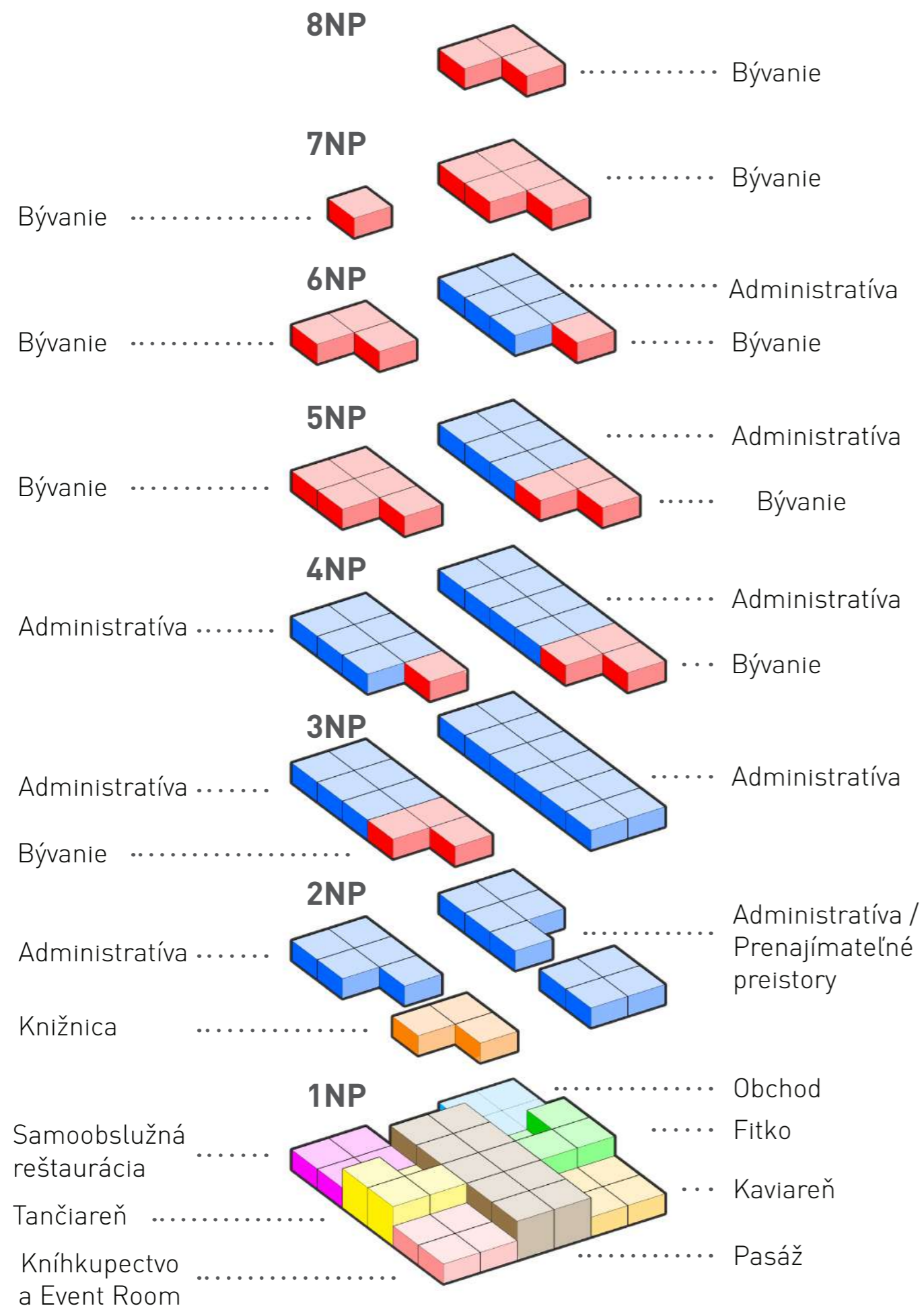

KONCEPT HORIZONTÁLNYCH A VERTIKÁLNYCH KOMUNIKÁCIÍ

NOBELOVA ULICA

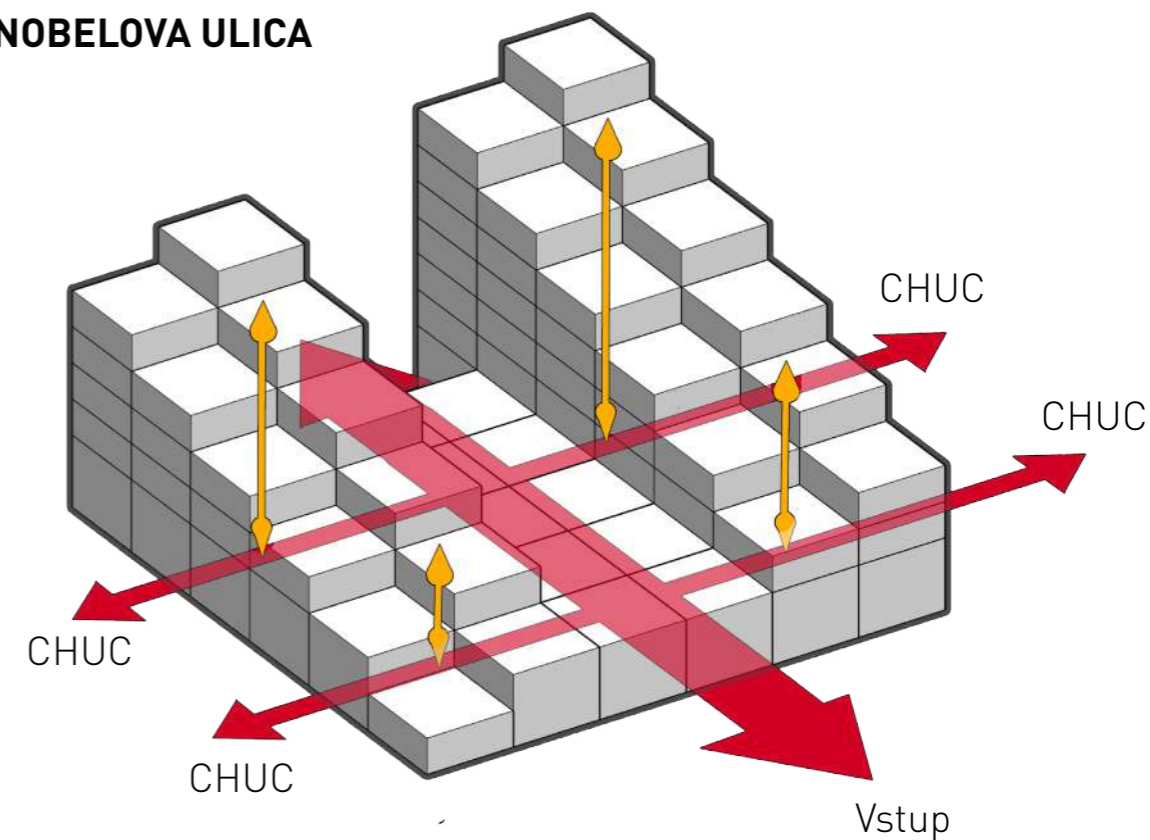

PARK

FUNKČNÝ KONCEPT

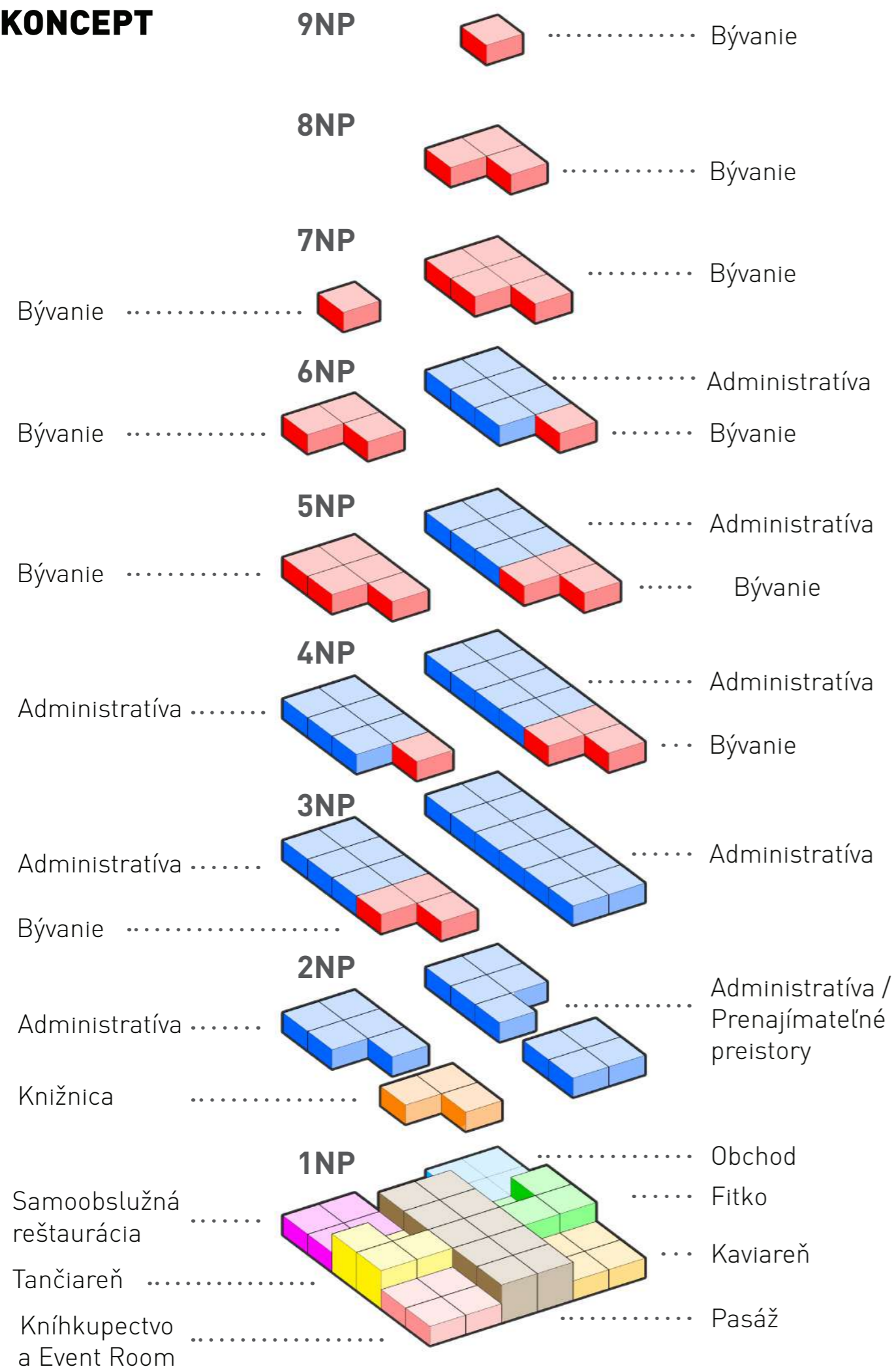

KONCEPT HORIZONTÁLNYCH A VERTIKÁLNYCH KOMUNIKÁCIÍ

NOBELOVA ULICA

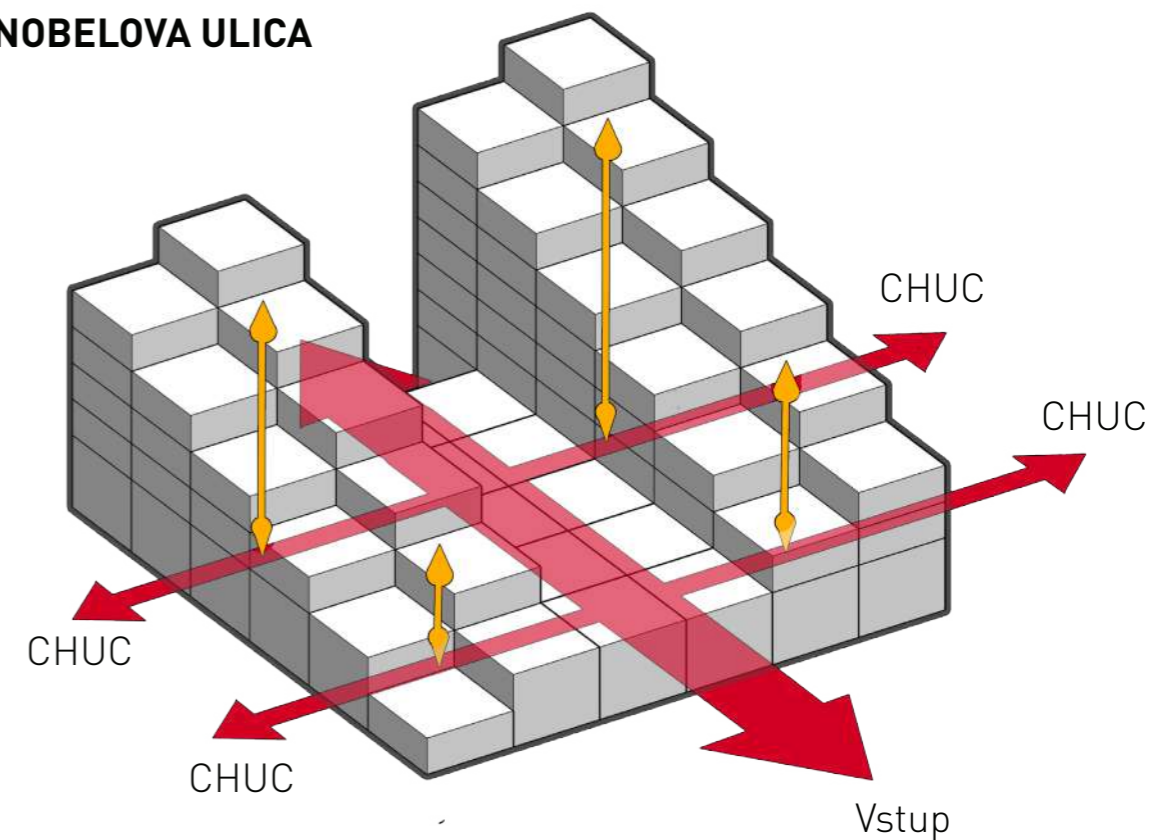

SITUÁCIA M_1:500



LEGENDA

- Hranica pozemku
- Navrhovaná cyklotrasa
- A** Časť A - Pasáž
- B** Časť B
- C** Časť C
- 1.** Ateliér Kusý - Paňák
- 2.** Predpolie budovy
- 3.** Parkovisko na teréne
- 4.** Vjazd do podzemnej garáže
- 5.** Stojisko pre zásobovanie
- 6.** Stojisko kontajnerov
- 7.** Parková úprava
- 8.** Zakladač na bicykle
- 9.** Stojany na bicykle



SITUÁCIA M_1:500



LEGENDA

- Hranica pozemku
- Navrhovaná cyklotrasa
- A** Časť A - Pasáž
- B** Časť B
- C** Časť C
- 1.** Ateliér Kusý - Paňák
- 2.** Predpolie budovy
- 3.** Parkovisko na teréne
- 4.** Vjazd do podzemnej garáže
- 5.** Stojisko pre zásobovanie
- 6.** Stojisko kontajnerov
- 7.** Parková úprava
- 8.** Zakladač na bicykle
- 9.** Stojany na bicykle



SITUÁCIA M_1:500



LEGENDA

- Hranica pozemku
- Navrhovaná cyklotrasa
- A** Časť A - Pasáž
- B** Časť B
- C** Časť C
- 1.** Ateliér Kusý - Paňák
- 2.** Predpolie budovy
- 3.** Parkovisko na teréne
- 4.** Vjazd do podzemnej garáže
- 5.** Stojisko pre zásobovanie
- 6.** Stojisko kontajnerov
- 7.** Parková úprava
- 8.** Zakladač na bicykle
- 9.** Stojany na bicykle



SITUÁCIA M_1:500



LEGENDA

- Hranica pozemku
- Navrhovaná cyklotrasa
- A** Časť A - Pasáž
- B** Časť B
- C** Časť C
- 1.** Ateliér Kusý - Paňák
- 2.** Predpolie budovy
- 3.** Parkovisko na teréne
- 4.** Vjazd do podzemnej garáže
- 5.** Stojisko pre zásobovanie
- 6.** Stojisko kontajnerov
- 7.** Parková úprava
- 8.** Zakladač na bicykle
- 9.** Stojany na bicykle



SITUÁCIA M_1:500



LEGENDA

- Hranica pozemku
- Navrhovaná cyklotrasa
- A** Časť A - Pasáž
- B** Časť B
- C** Časť C
- 1.** Ateliér Kusý - Paňák
- 2.** Predpolie budovy
- 3.** Parkovisko na teréne
- 4.** Vjazd do podzemnej garáže
- 5.** Stojisko pre zásobovanie
- 6.** Stojisko kontajnerov
- 7.** Parková úprava
- 8.** Zakladač na bicykle
- 9.** Stojany na bicykle



SITUÁCIA M_1:500



LEGENDA

- Hranica pozemku
- Navrhovaná cyklotrasa
- A** Časť A - Pasáž
- B** Časť B
- C** Časť C
- 1.** Ateliér Kusý - Paňák
- 2.** Predpolie budovy
- 3.** Parkovisko na teréne
- 4.** Vjazd do podzemnej garáže
- 5.** Stojisko pre zásobovanie
- 6.** Stojisko kontajnerov
- 7.** Parková úprava
- 8.** Zakladač na bicykle
- 9.** Stojany na bicykle



SITUÁCIA M_1:500



LEGENDA

- Hranica pozemku
- Navrhovaná cyklotrasa
- A** Časť A - Pasáž
- B** Časť B
- C** Časť C
- 1.** Ateliér Kusý - Paňák
- 2.** Predpolie budovy
- 3.** Parkovisko na teréne
- 4.** Vjazd do podzemnej garáže
- 5.** Stojisko pre zásobovanie
- 6.** Stojisko kontajnerov
- 7.** Parková úprava
- 8.** Zakladač na bicykle
- 9.** Stojany na bicykle



1NP

LEGENDA

- Vstupná hala, kom. pr.
- Obchod
- Fitko
- Hygienické jadro
- Kaviareň
- Kníhkupectvo
- Event room
- Tančiareň, Filmový ateliér
- Reštaurácia
- Technické a obslužné pr.

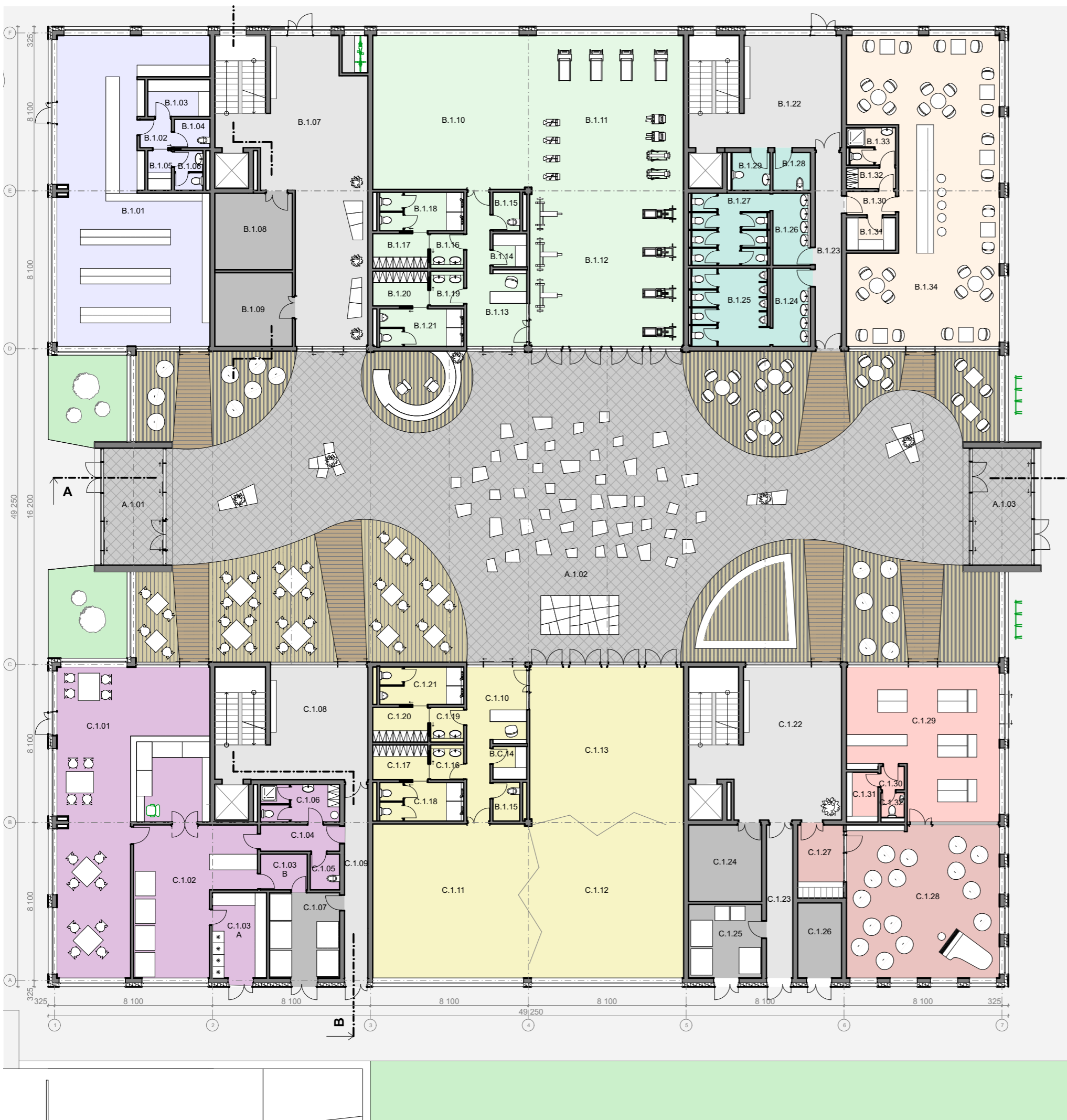

1NP

LEGENDA

- Vstupná hala, kom. pr.
- Obchod
- Fitko
- Hygienické jadro
- Kaviareň
- Kníhkupectvo
- Event room
- Tančiareň, Filmový ateliér
- Reštaurácia
- Technické a obslužné pr.



1NP

LEGENDA

- Vstupná hala, kom. pr.
- Obchod
- Fitko
- Hygienické jadro
- Kaviareň
- Kníhkupectvo
- Event room
- Tančiareň, Filmový ateliér
- Reštaurácia
- Technické a obslužné pr.



1NP

LEGENDA

- Vstupná hala, kom. pr.
- Obchod
- Fitko
- Hygienické jadro
- Kaviareň
- Kníhkupectvo
- Event room
- Tančiareň, Filmový ateliér
- Reštaurácia
- Technické a obslužné pr.

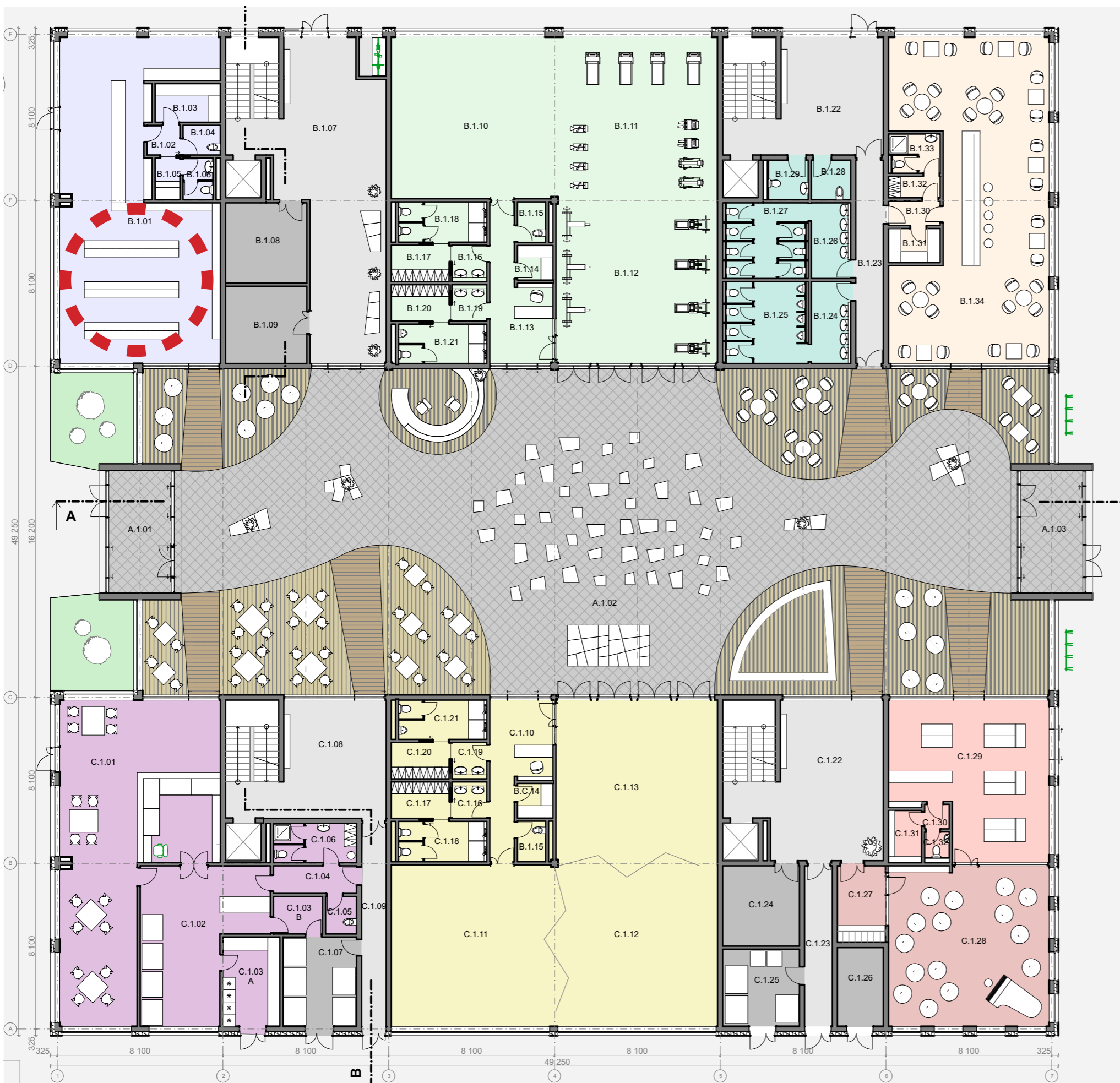

1NP

LEGENDA

- Vstupná hala, kom. pr.
- Obchod
- Fitko
- Hygienické jadro
- Kaviareň
- Kníhkupectvo
- Event room
- Tančiareň, Filmový ateliér
- Reštaurácia
- Technické a obslužné pr.

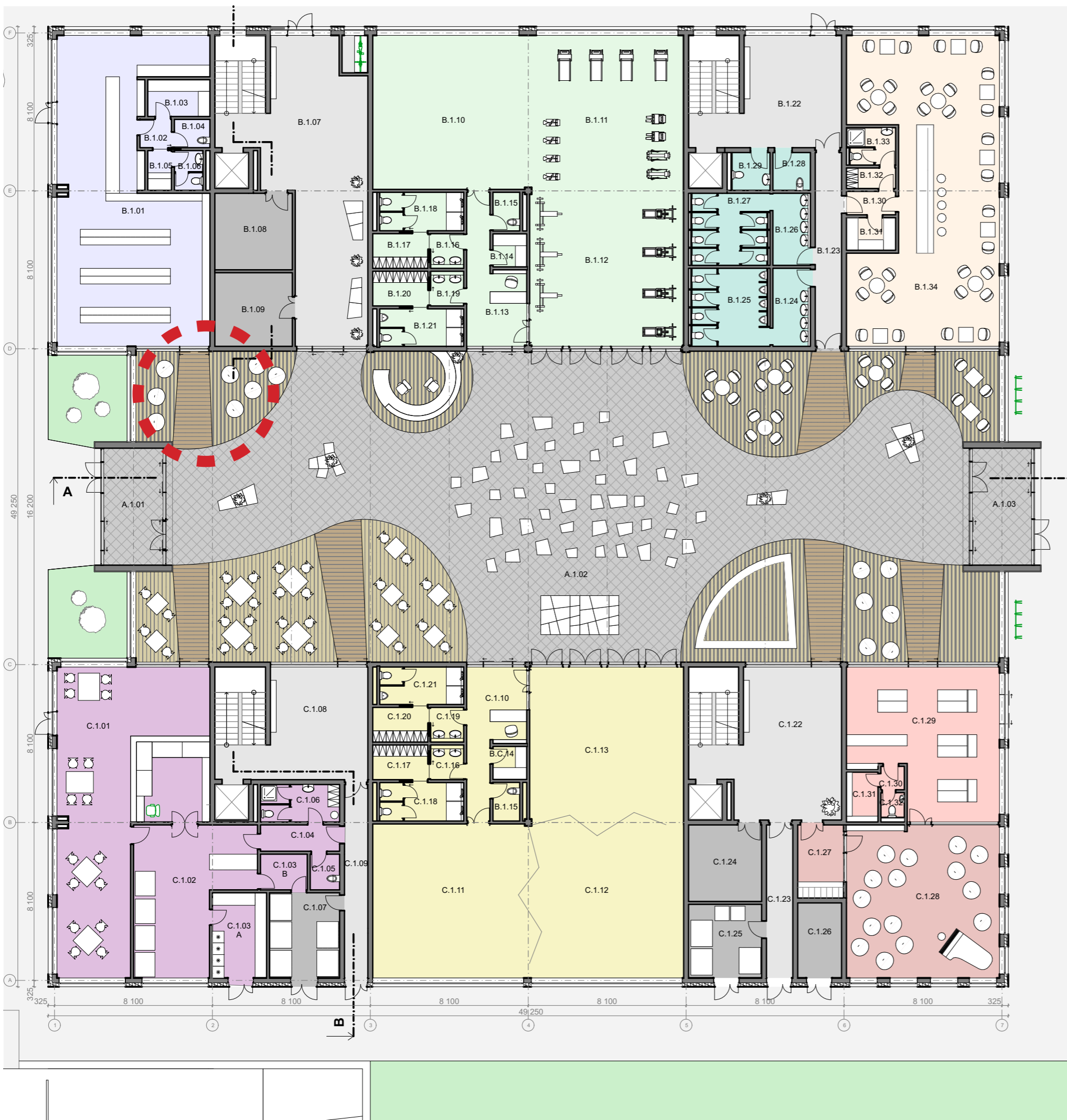

1NP

LEGENDA

- Vstupná hala, kom. pr.
- Obchod
- Fitko
- Hygienické jadro
- Kaviareň
- Kníhkupectvo
- Event room
- Tančiareň, Filmový ateliér
- Reštaurácia
- Technické a obslužné pr.

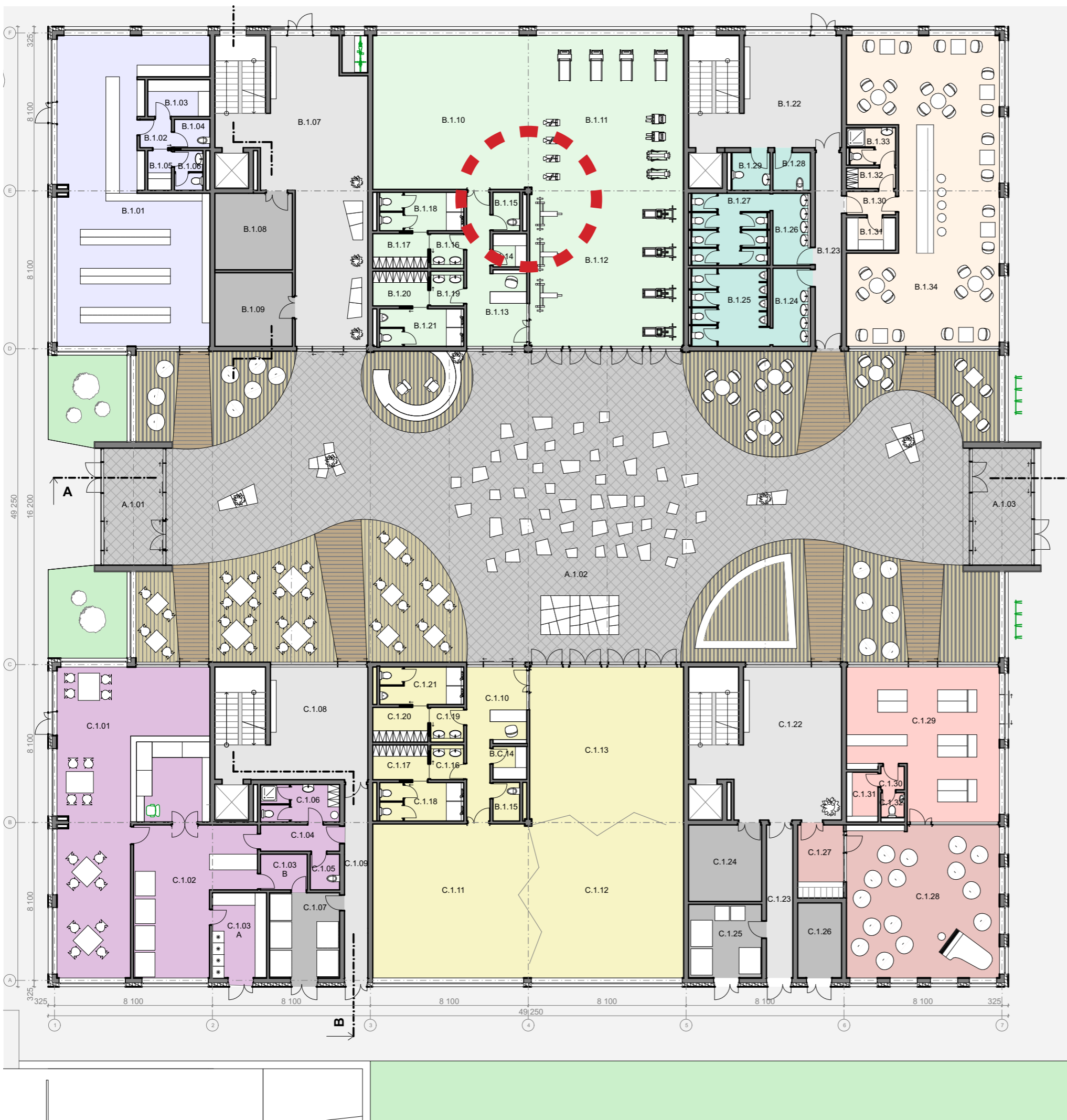

1NP

LEGENDA

- Vstupná hala, kom. pr.
- Obchod
- Fitko
- Hygienické jadro
- Kaviareň
- Kníhkupectvo
- Event room
- Tančiareň, Filmový ateliér
- Reštaurácia
- Technické a obslužné pr.

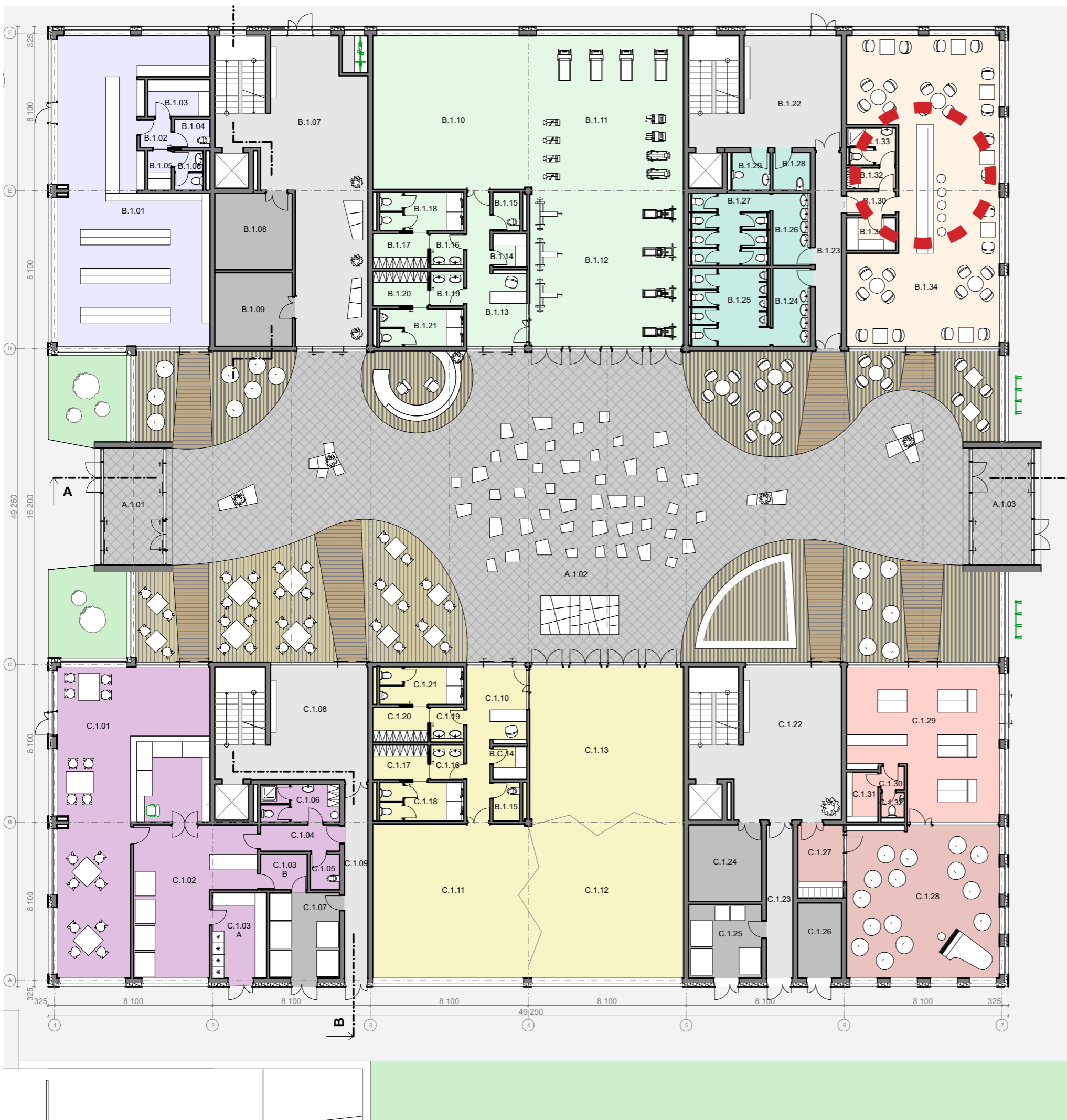

1NP

LEGENDA

- Vstupná hala, kom. pr.
- Obchod
- Fitko
- Hygienické jadro
- Kaviareň
- Kníhkupectvo
- Event room
- Tančiareň, Filmový ateliér
- Reštaurácia
- Technické a obslužné pr.

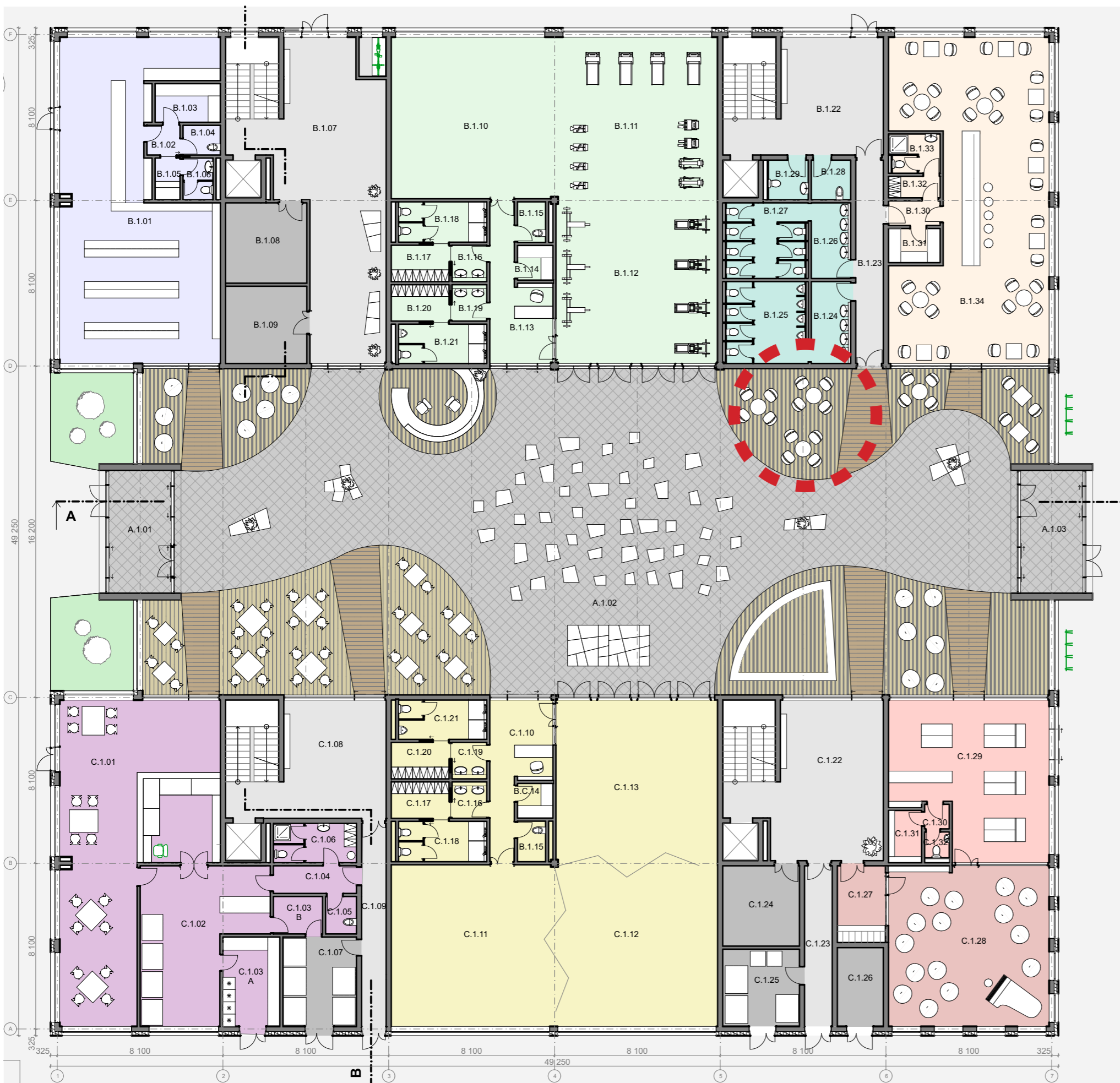

1NP

LEGENDA

- Vstupná hala, kom. pr.
- Obchod
- Fitko
- Hygienické jadro
- Kaviareň
- Kníhkupectvo
- Event room
- Tančiareň, Filmový ateliér
- Reštaurácia
- Technické a obslužné pr.

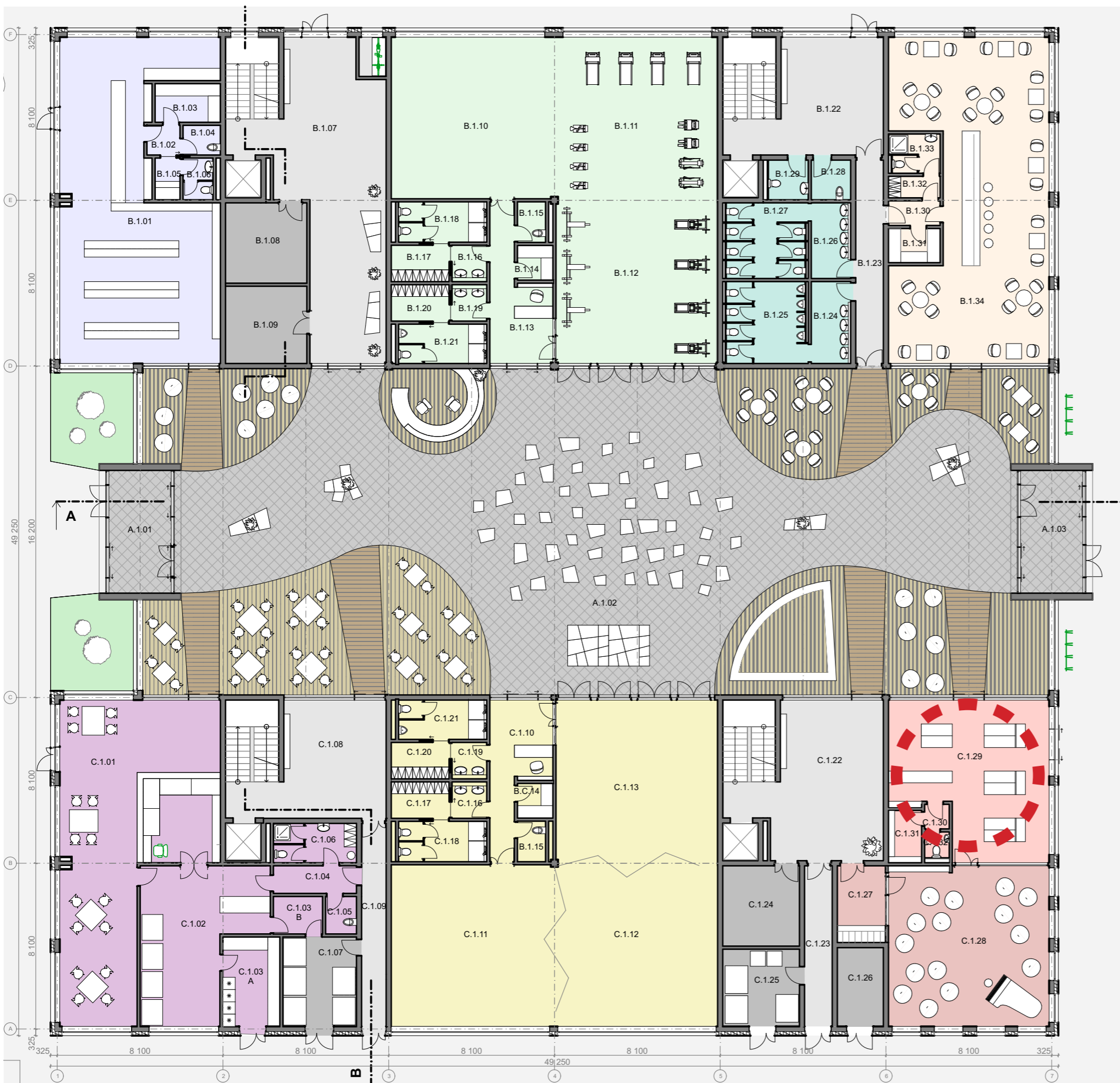

1NP

LEGENDA

- Vstupná hala, kom. pr.
- Obchod
- Fitko
- Hygienické jadro
- Kaviareň
- Kníhkupectvo
- Event room
- Tančiareň, Filmový ateliér
- Reštaurácia
- Technické a obslužné pr.

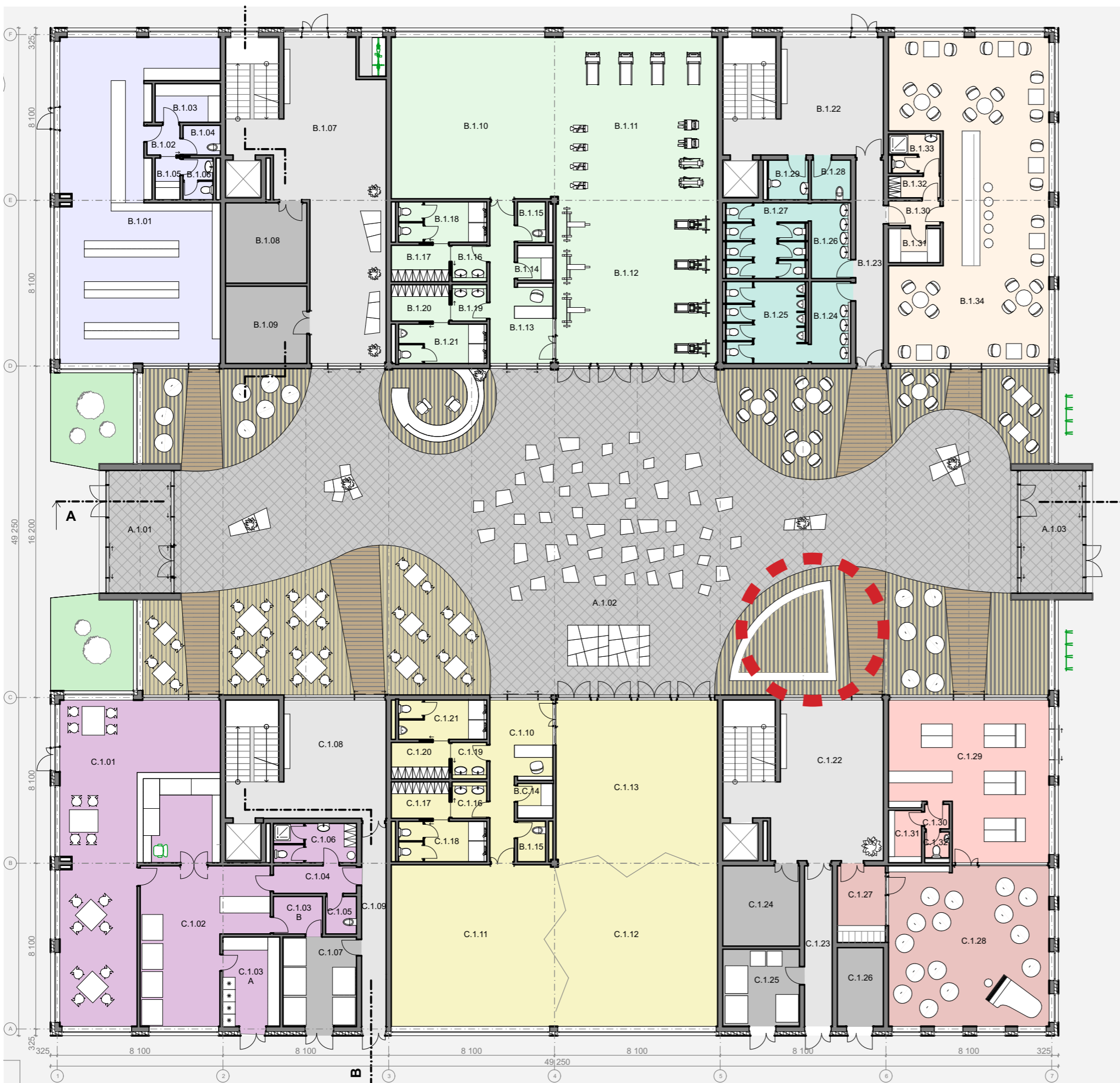

1NP

LEGENDA

- Vstupná hala, kom. pr.
- Obchod
- Fitko
- Hygienické jadro
- Kaviareň
- Kníhkupectvo
- Event room
- Tančiareň, Filmový ateliér
- Reštaurácia
- Technické a obslužné pr.

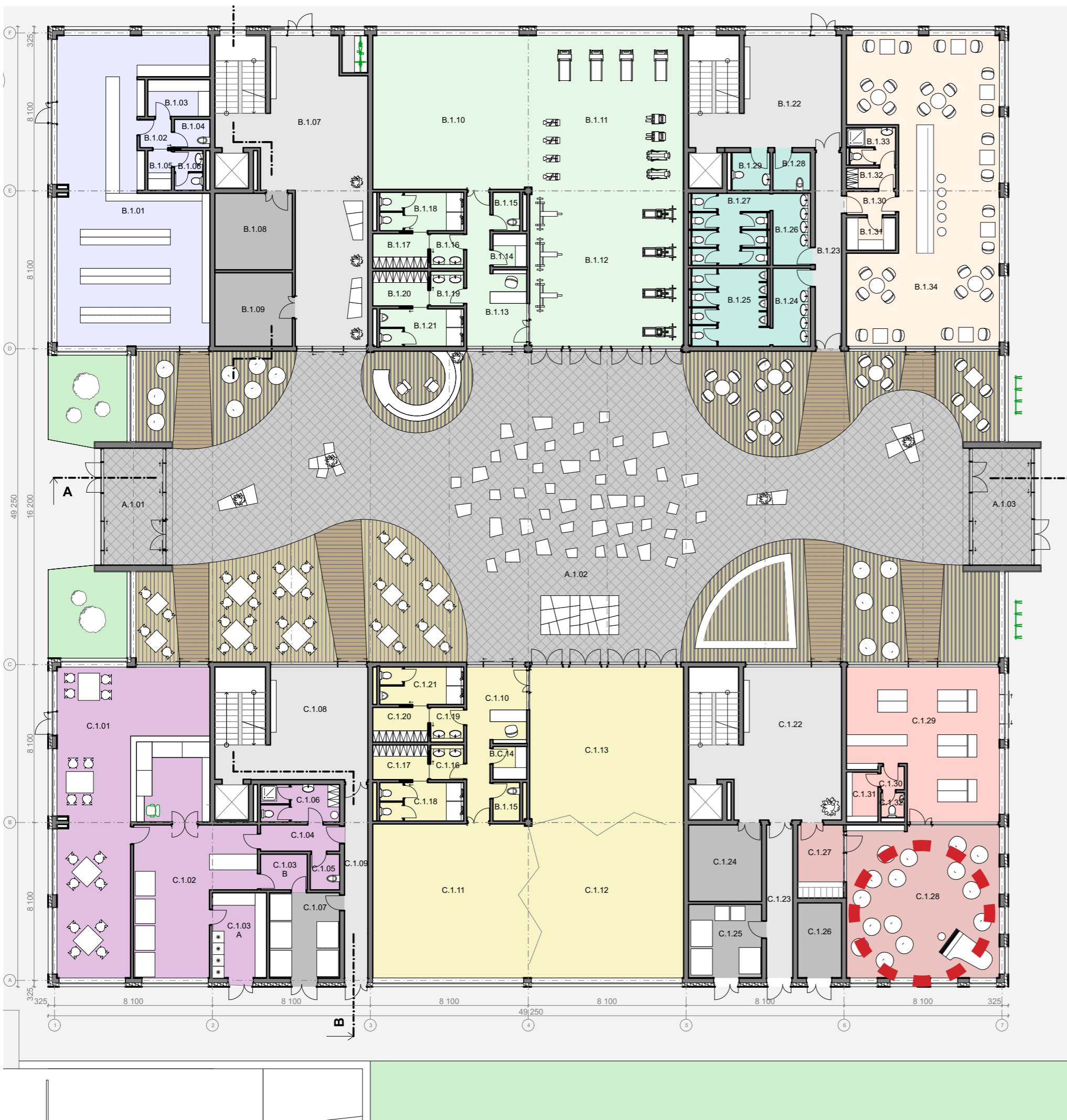

1NP

LEGENDA

- Vstupná hala, kom. pr.
- Obchod
- Fitko
- Hygienické jadro
- Kaviareň
- Kníhkupectvo
- Event room
- Tančiareň, Filmový ateliér
- Reštaurácia
- Technické a obslužné pr.

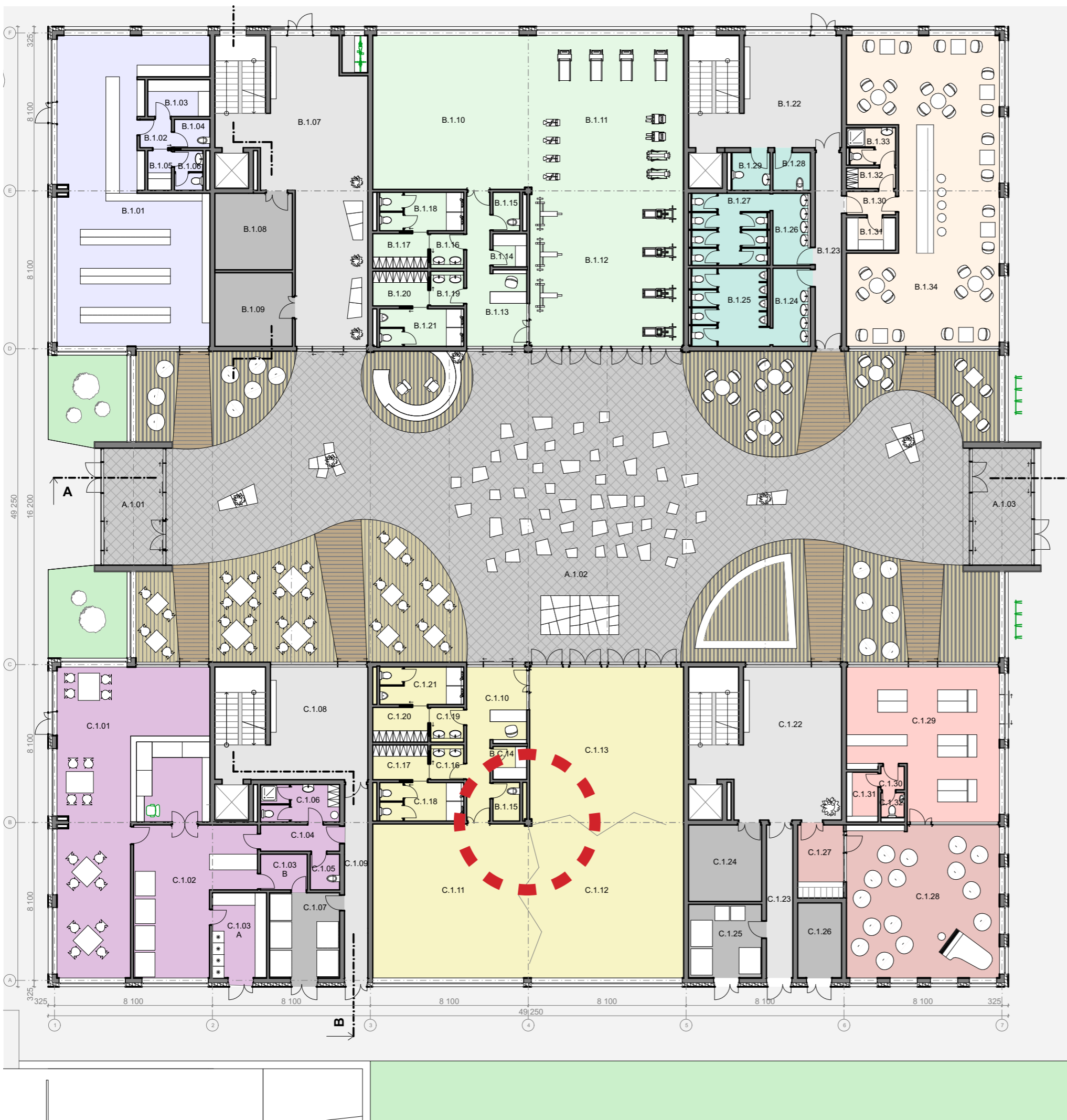

1NP

LEGENDA

- Vstupná hala, kom. pr.
- Obchod
- Fitko
- Hygienické jadro
- Kaviareň
- Kníhkupectvo
- Event room
- Tančiareň, Filmový ateliér
- Reštaurácia
- Technické a obslužné pr.

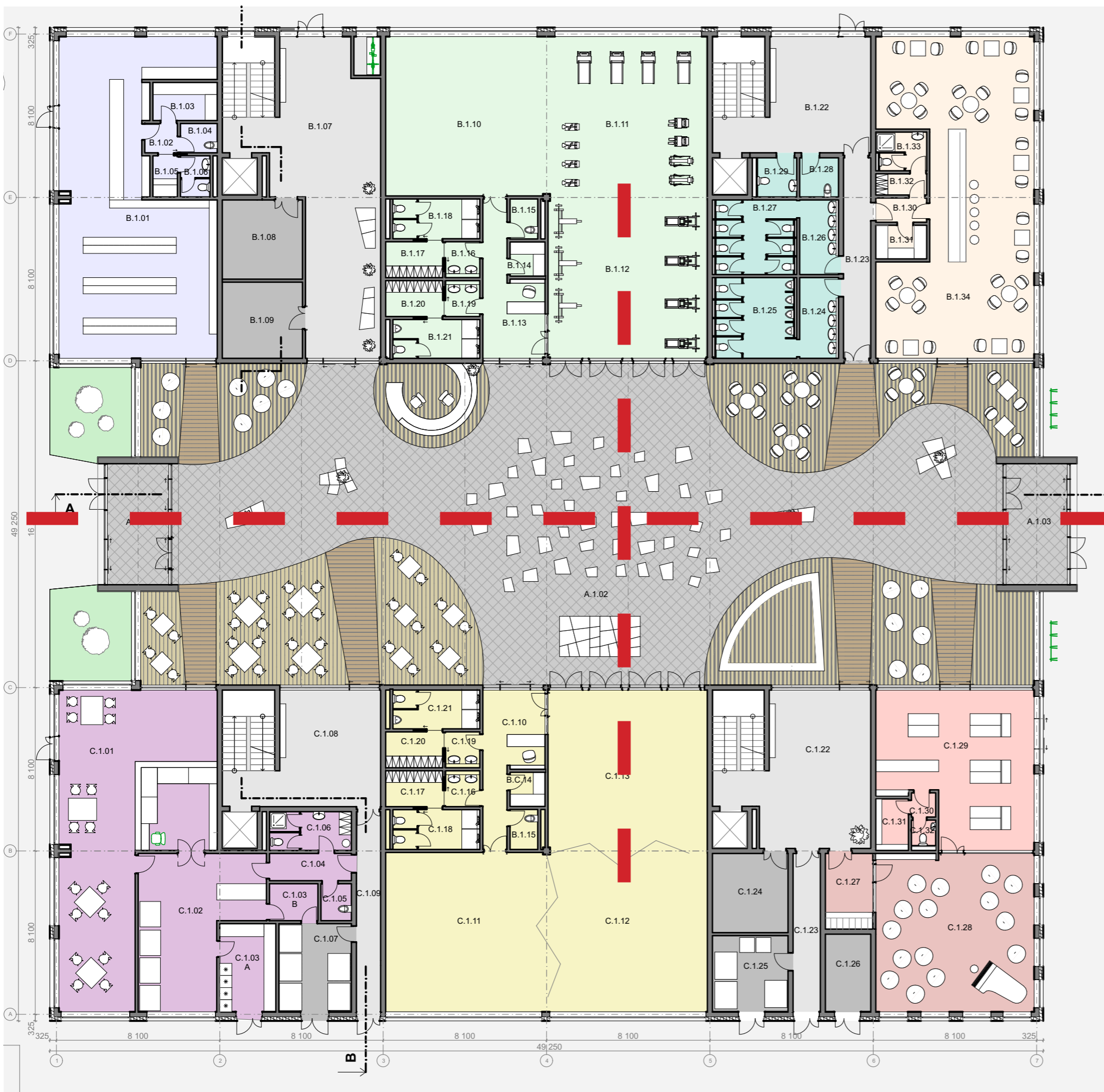

1NP

LEGENDA

- Vstupná hala, kom. pr.
- Obchod
- Fitko
- Hygienické jadro
- Kaviareň
- Kníhkupectvo
- Event room
- Tančiareň, Filmový ateliér
- Reštaurácia
- Technické a obslužné pr.

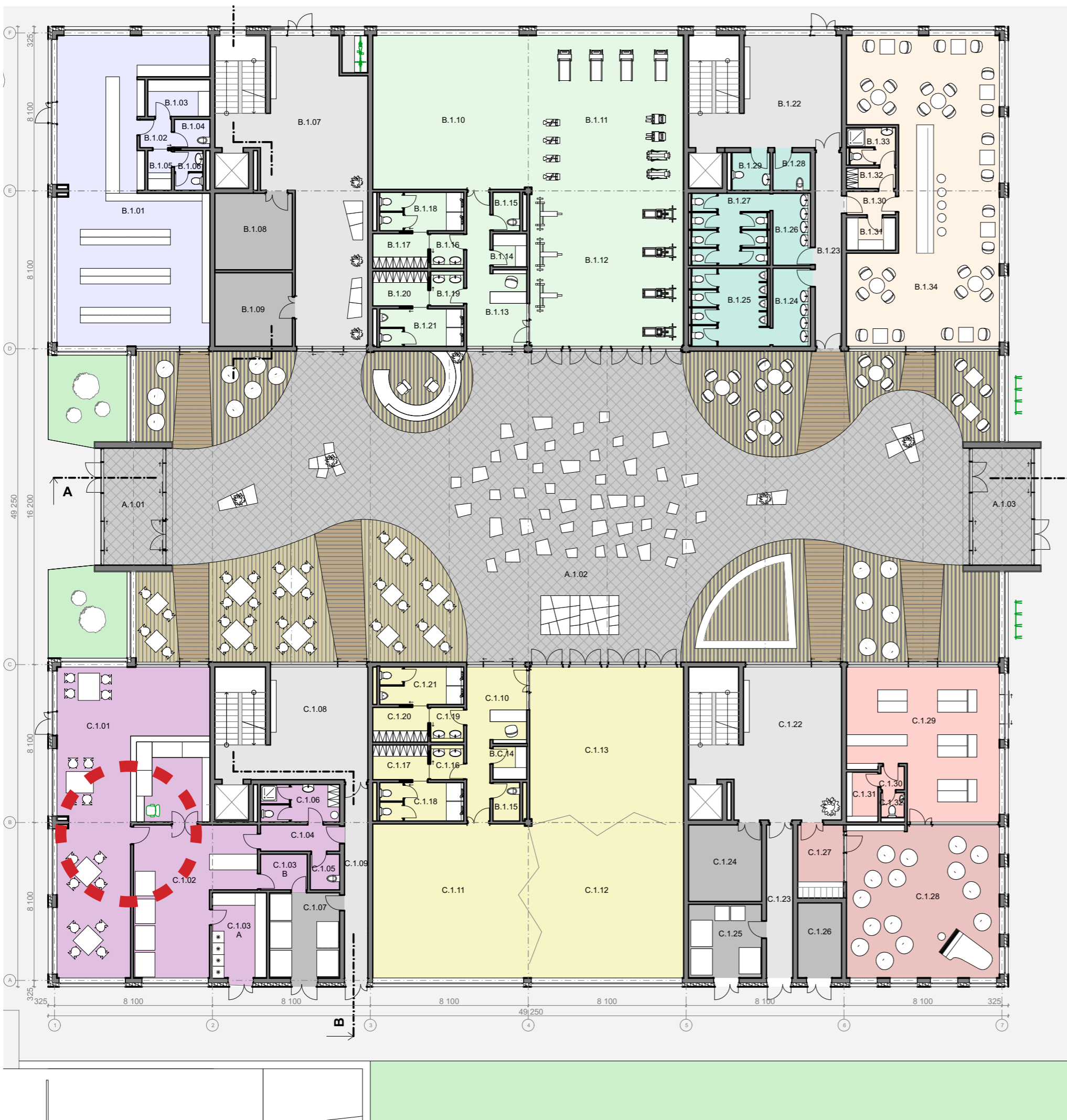

1NP

LEGENDA

- Vstupná hala, kom. pr.
- Obchod
- Fitko
- Hygienické jadro
- Kaviareň
- Kníhkupectvo
- Event room
- Tančiareň, Filmový ateliér
- Reštaurácia
- Technické a obslužné pr.

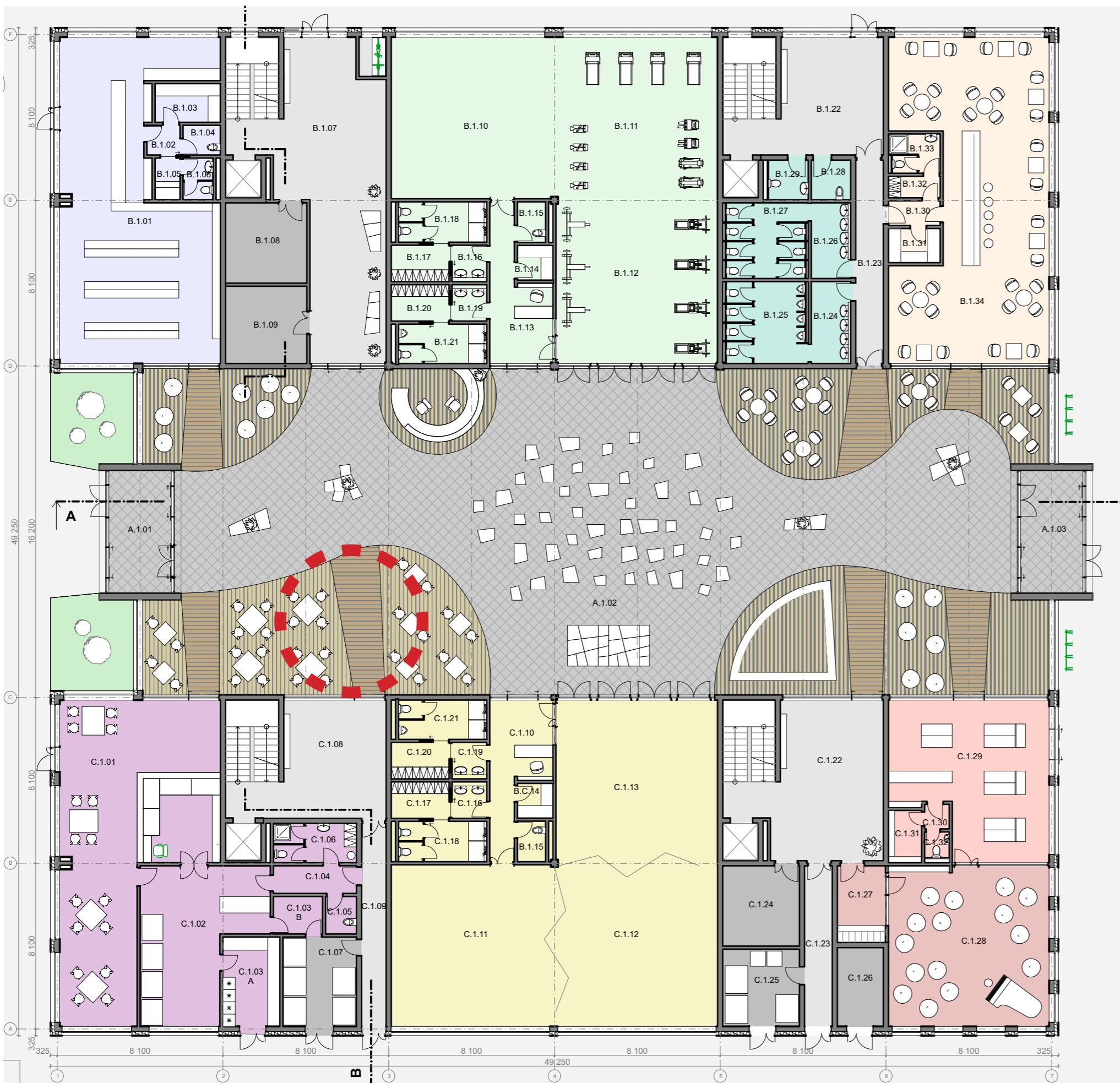

1NP

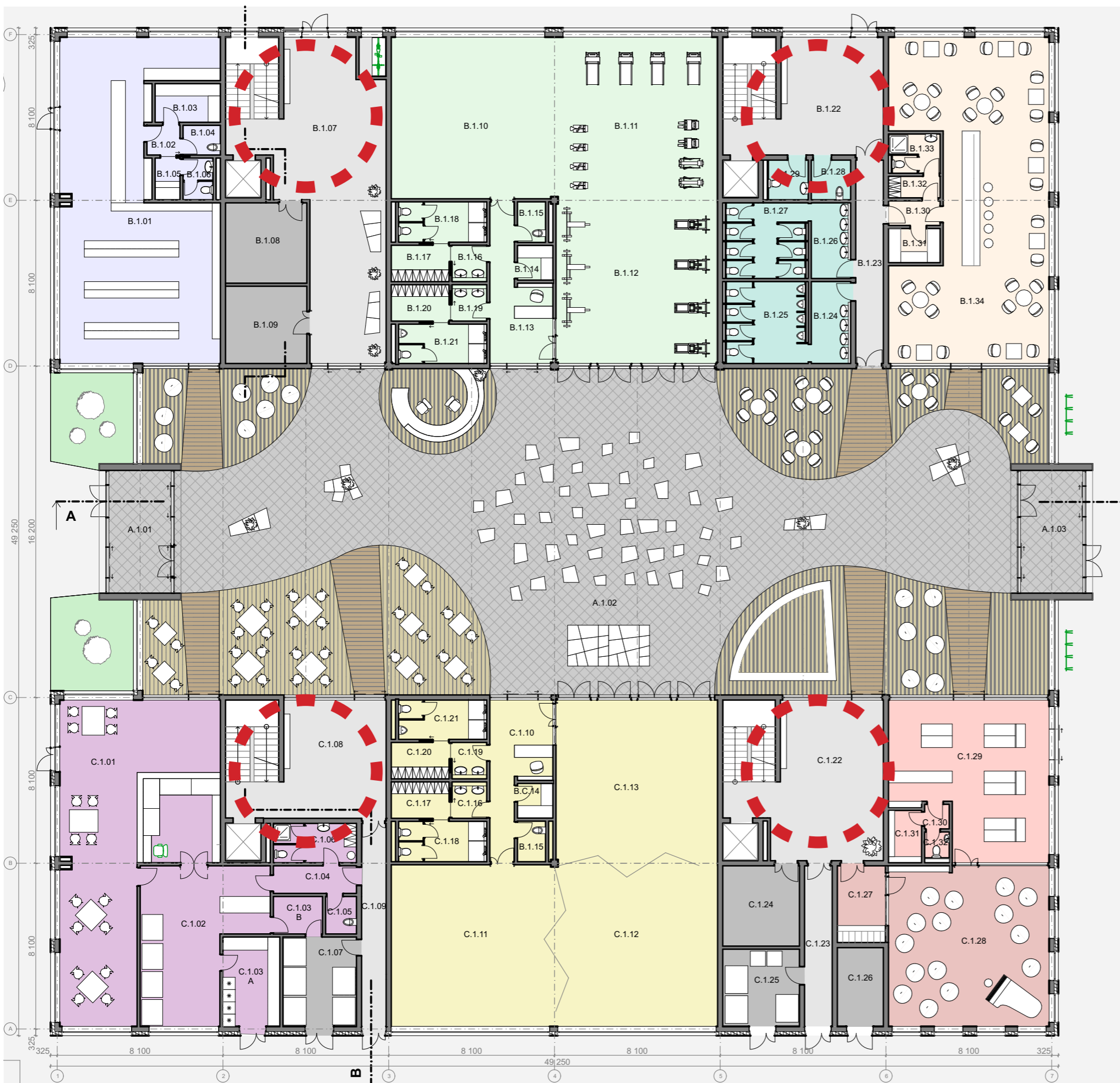

LEGENDA

- Vstupná hala, kom. pr.
- Obchod
- Fitko
- Hygienické jadro
- Kaviareň
- Kníhkupectvo
- Event room
- Tančiareň, Filmový ateliér
- Reštaurácia
- Technické a obslužné pr.



2NP

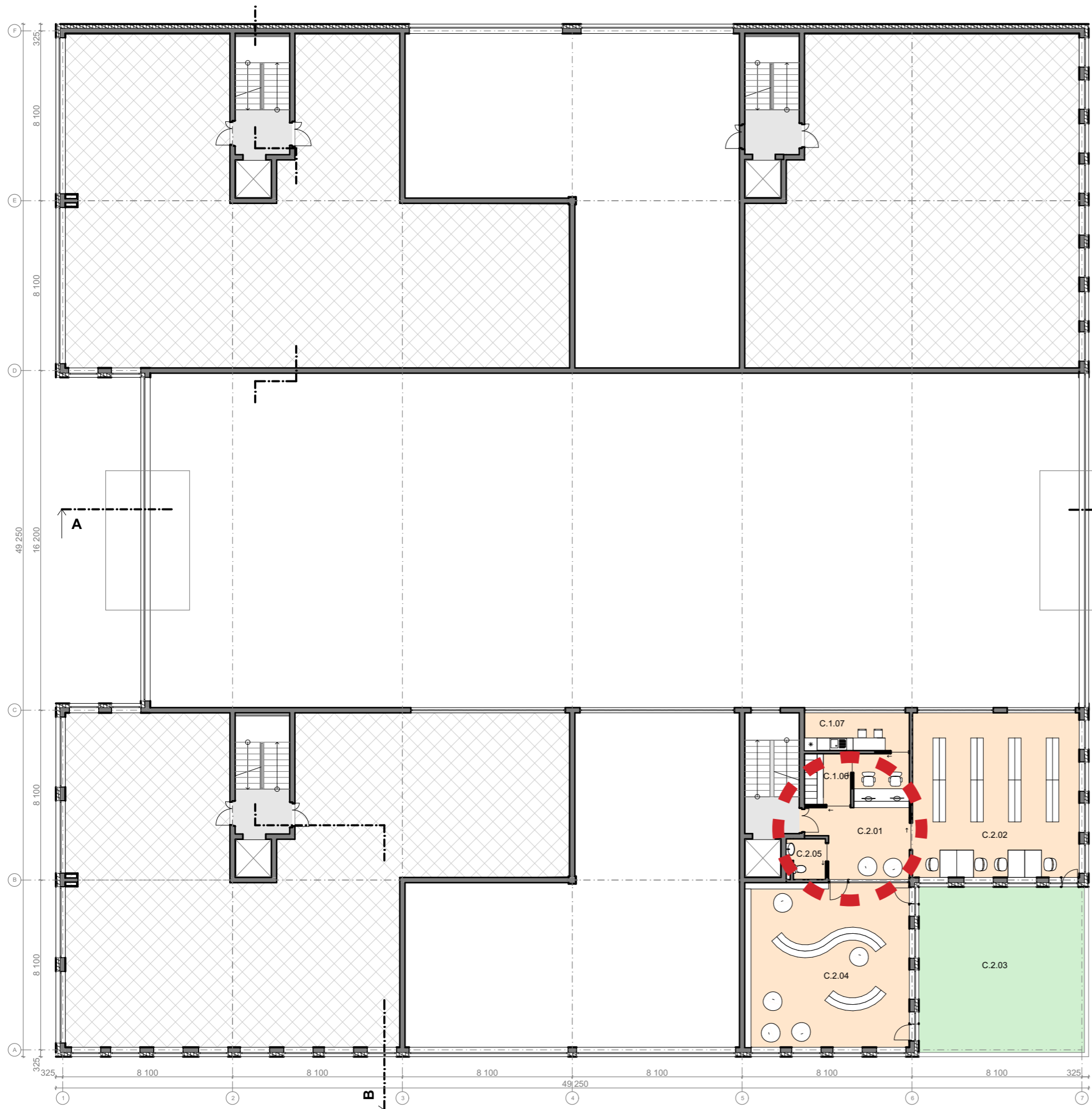

LEGENDA

-  Knižnica
-  Administratíva (vid'. alternatívne riešenia)



2NP



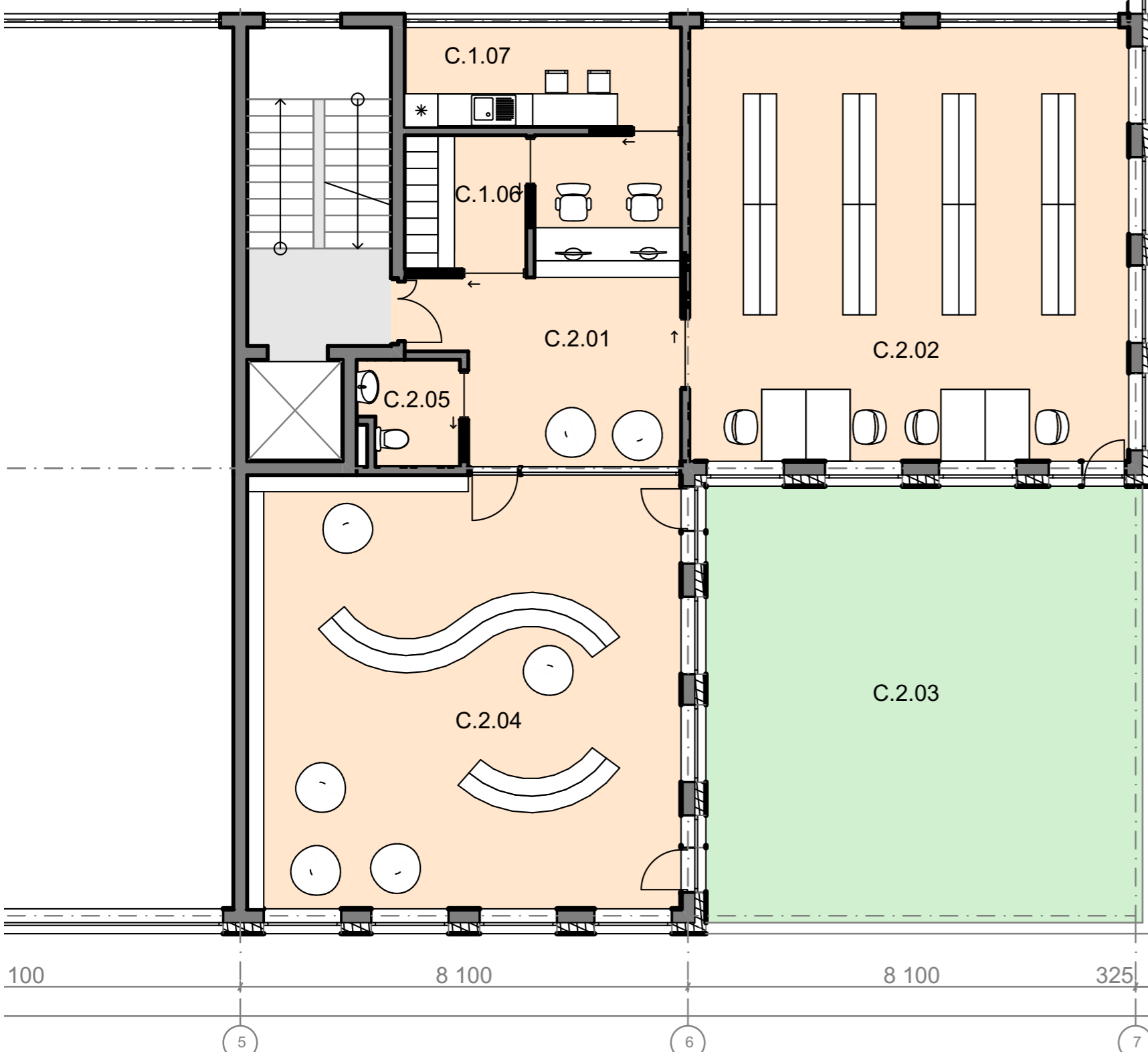

LEGENDA

-  Knižnica
-  Administratíva (vid'. alternatívne riešenia)



3NP





LEGENDA

-  4-izbový byt - mezonet
-  3-izbový byt
-  1,5-izbový byt
-  Administratíva (vid' alternatívne riešenia)



4NP

LEGENDA







-  4-izbový byt - mezonet
-  3-izbový byt
-  2-izbový byt
-  1-izbový byt
-  Administratíva (vid'. alternatívne riešenia)



5NP



LEGENDA







-  4-izbový byt - mezonet
-  3-izbový byt
-  2-izbový byt
-  1,5-izbový byt
-  1-izbový byt
-  Garžónka
-  Administratíva (vid'. alternatívne riešenia)



5NP



LEGENDA

-  4-izbový byt - mezonet
-  3-izbový byt
-  2-izbový byt
-  1,5-izbový byt
-  1-izbový byt
-  Garzónka
-  Administratíva (vid'. alternatívne riešenia)





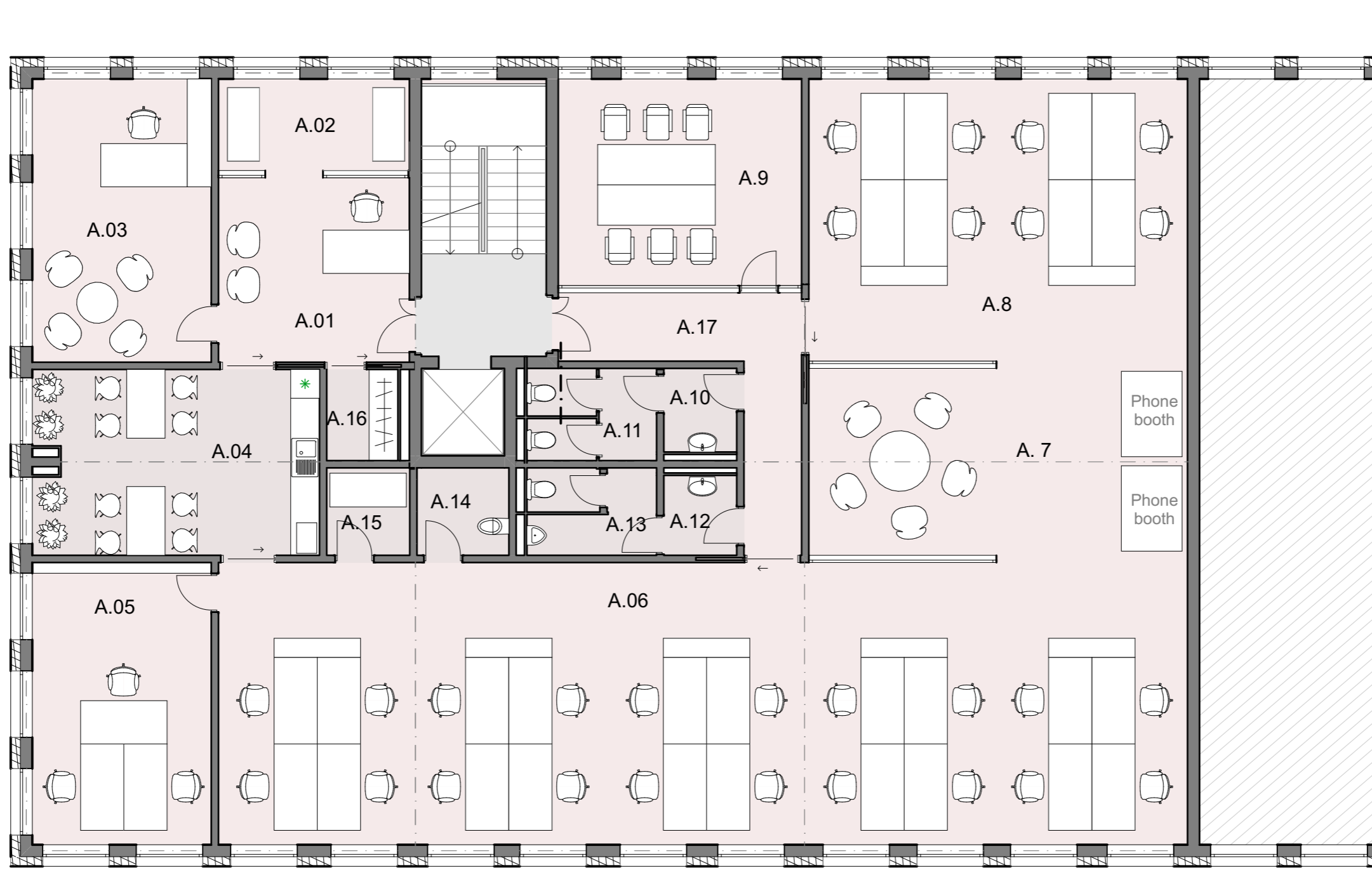

ADMINISTRATÍVNA ČASŤ

VERZIA 2: OPEN SPACE



6NP

LEGENDA

-  4-izbový byt
-  3-izbový byt
-  1,5-izbový byt
-  Administratíva (vid'. alternatívne riešenia)



7NP



LEGENDA

-  4-izbový byt - mezonet
-  3-izbový byt
-  2-izbový byt
-  1-izbový byt
-  garzónka

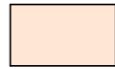

8NP

LEGENDA

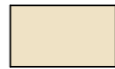
-  4-izbový byt - mezonet
-  3-izbový byt
-  1,5-izbový byt

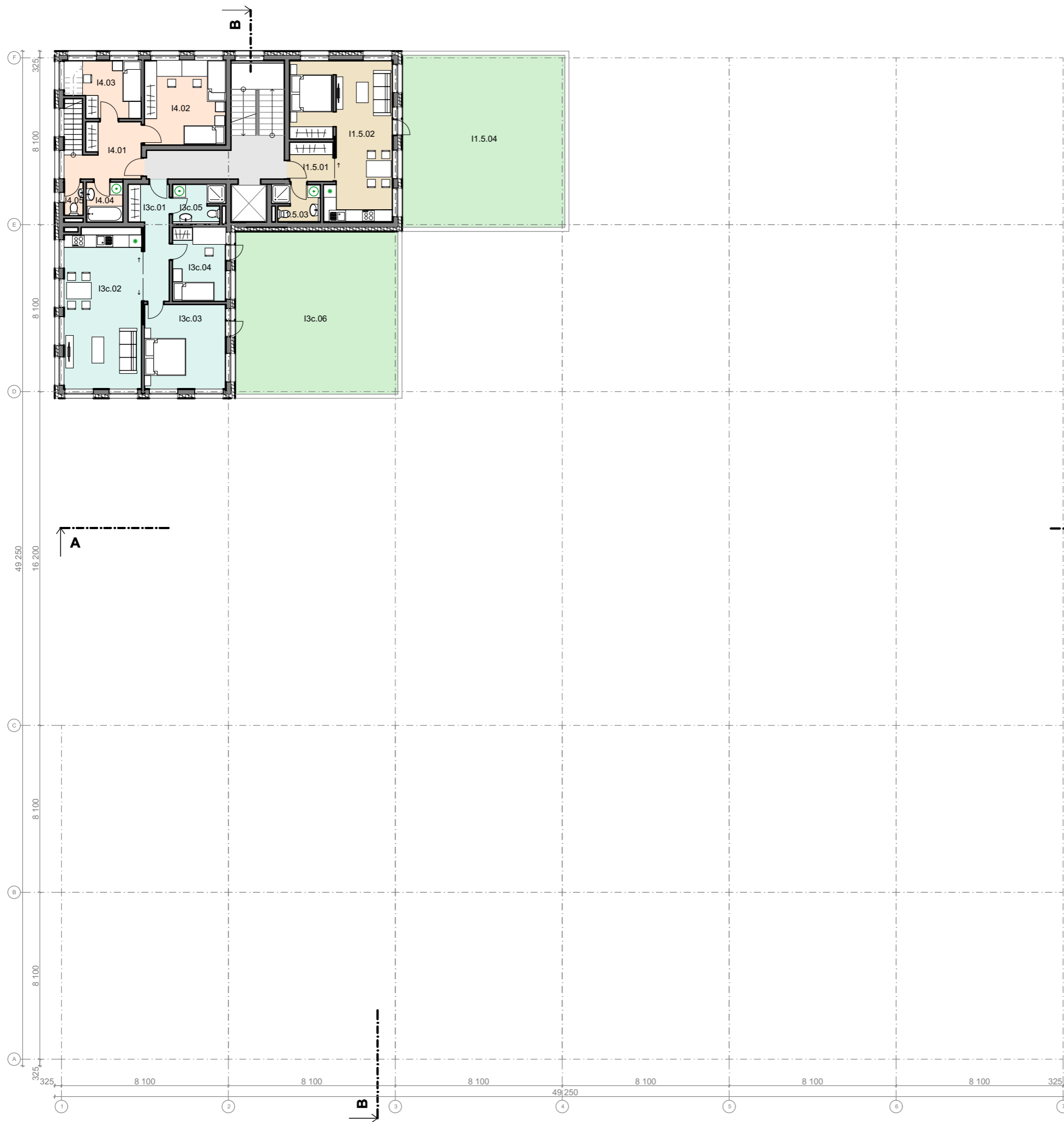

9NP

LEGENDA

 4-izbový byt - mezonet

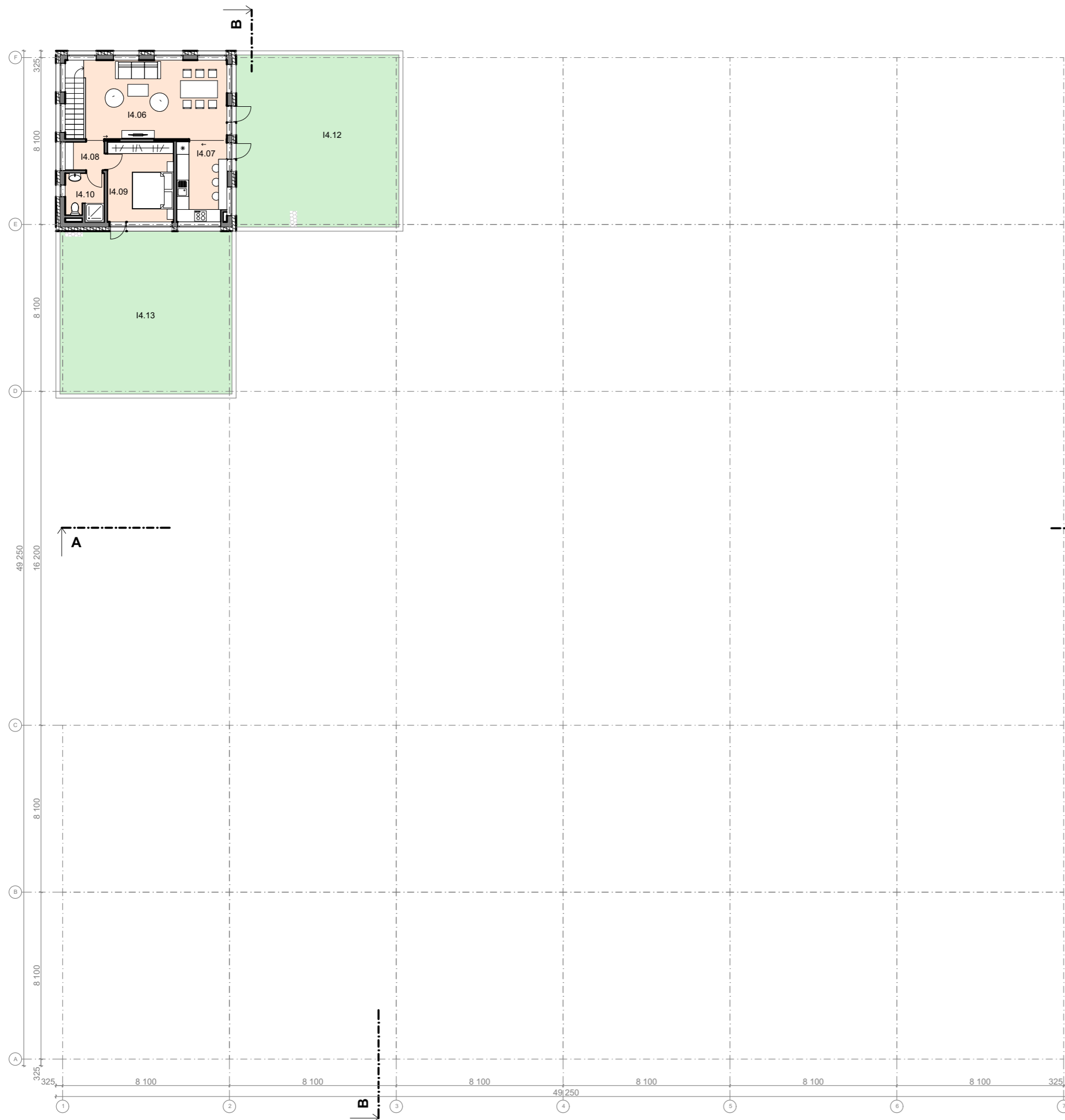

REZ A-A

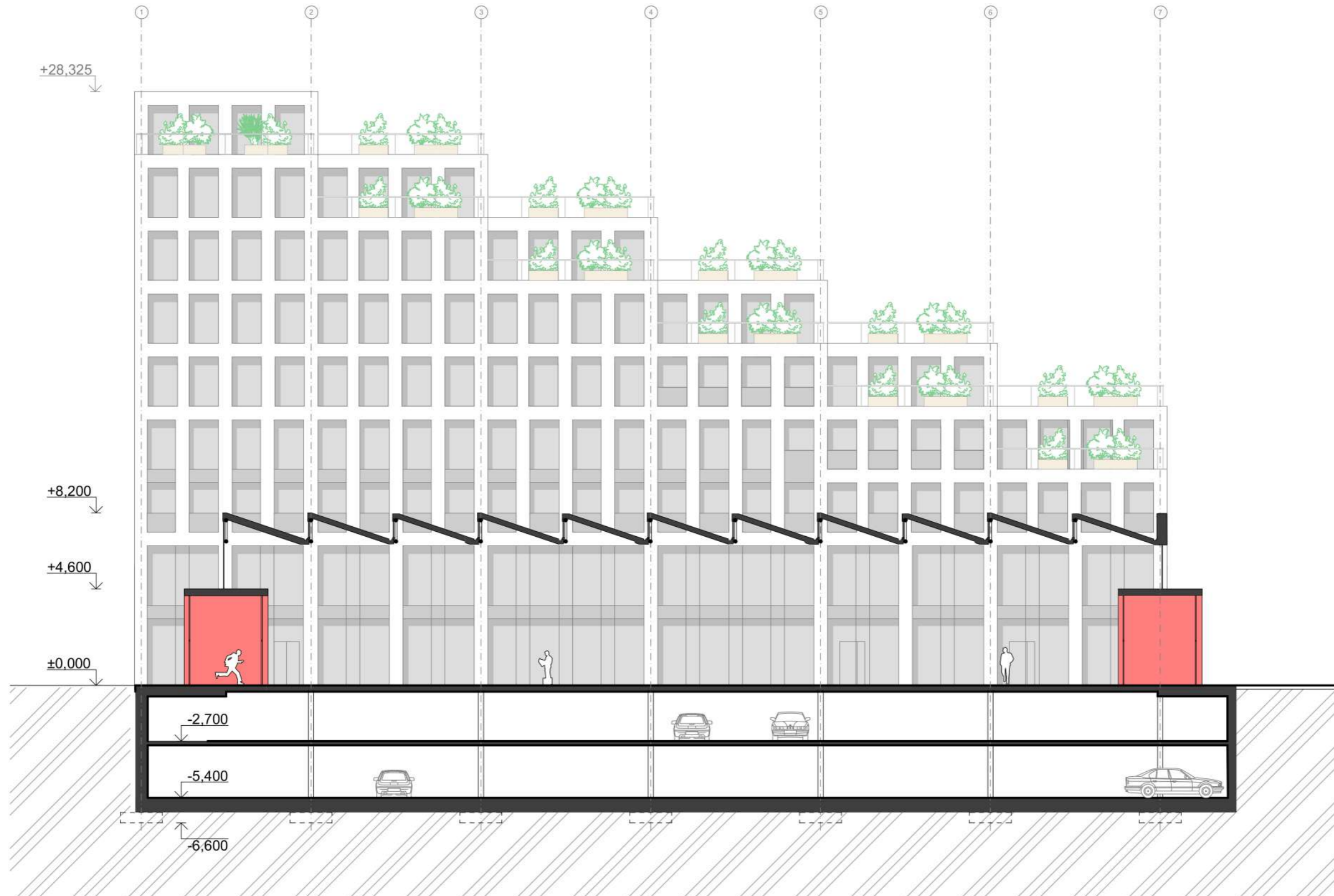

POHLÁD SEVEROZÁPADNÝ



POHLÁD SEVEROVÝCHOD-



POHLÁD JUHOVÝCHODNÝ



POHLÁD JUHOZÁPADNÝ









PASÍVNE VYUŽÍVANIE SOLÁRNYCH ZISKOV A OCHRANA PRED PREHRIATÍM

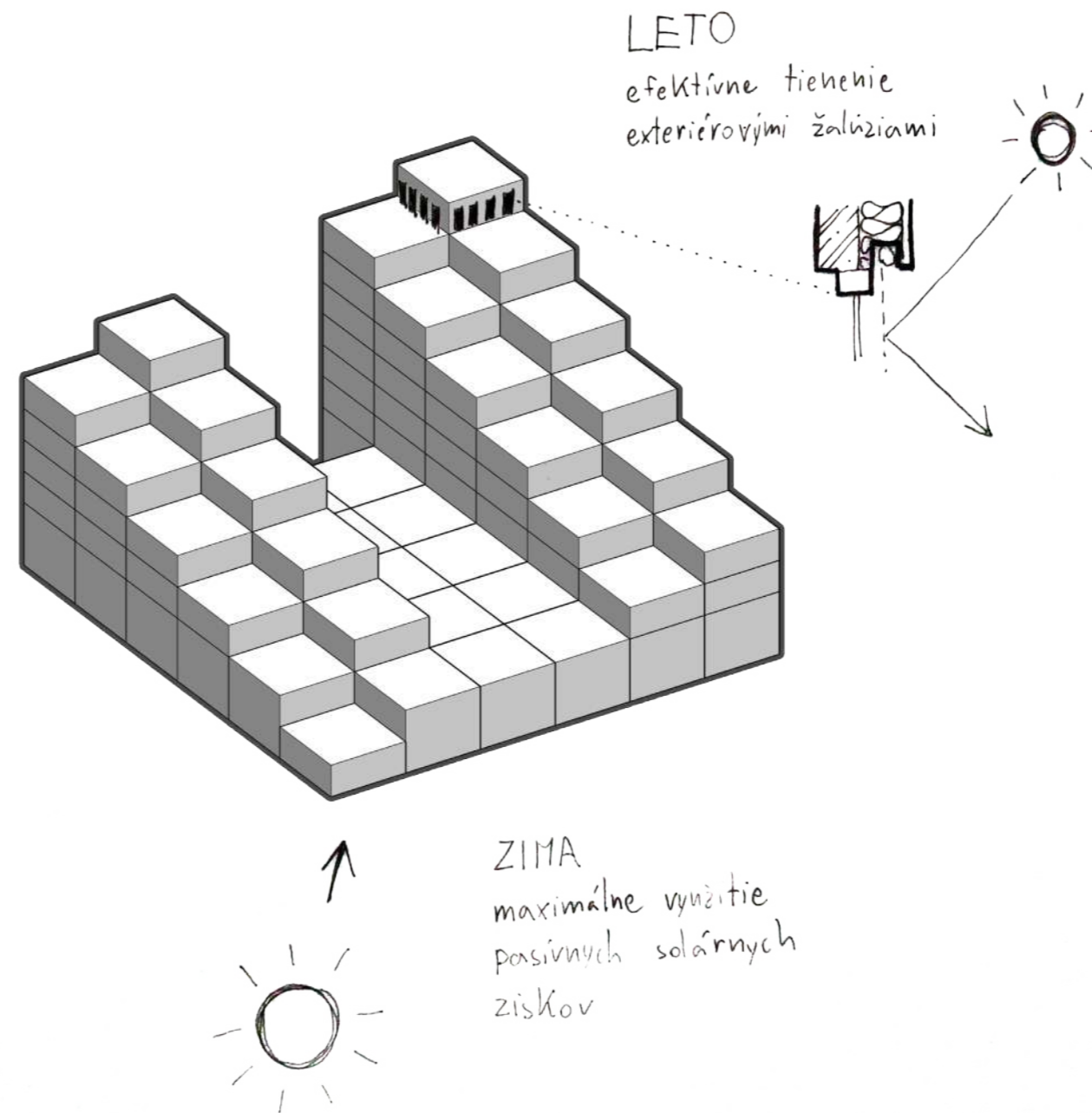

VYKUROVANIE A MINIMALIZÁCIA SPOTREBY ENERGIE

DOSTATOK T.I. resp.
ELIMINÁCIA T.M.

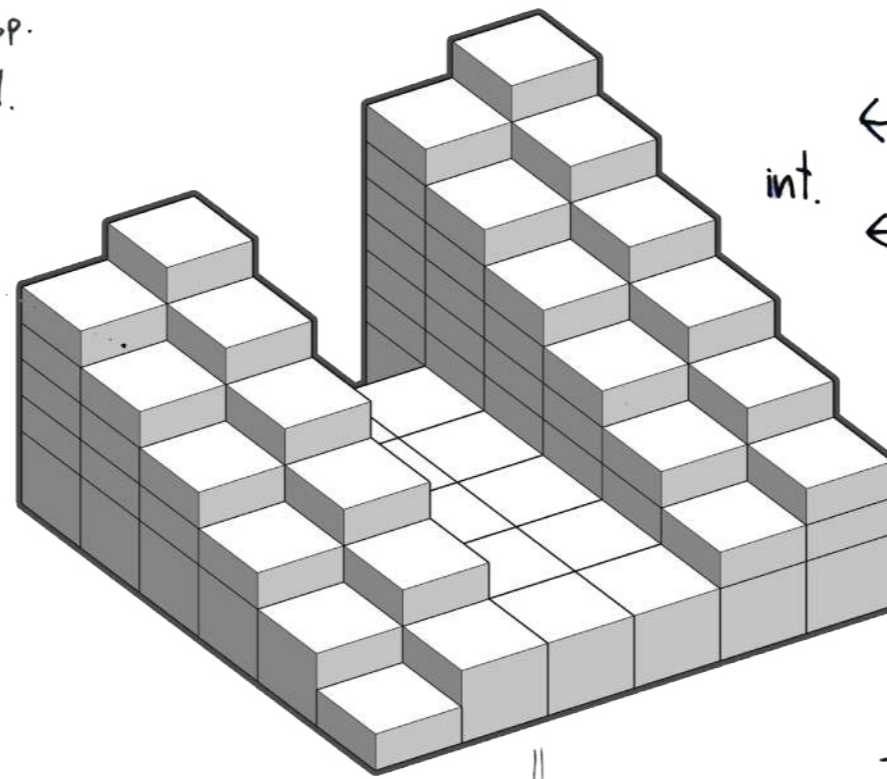
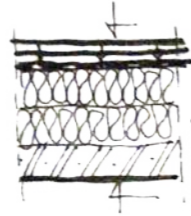

VETRAMIE S
REKUPERÁCIOU

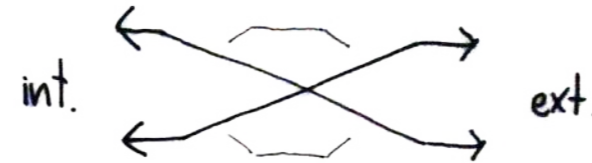

TEPELNÉ ČERPADLO
zem/voda - vrt

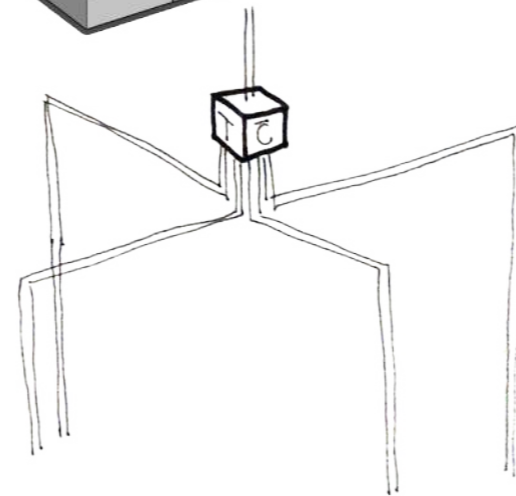

VYUŽÍVANIE DAŽĐOVEJ VODY

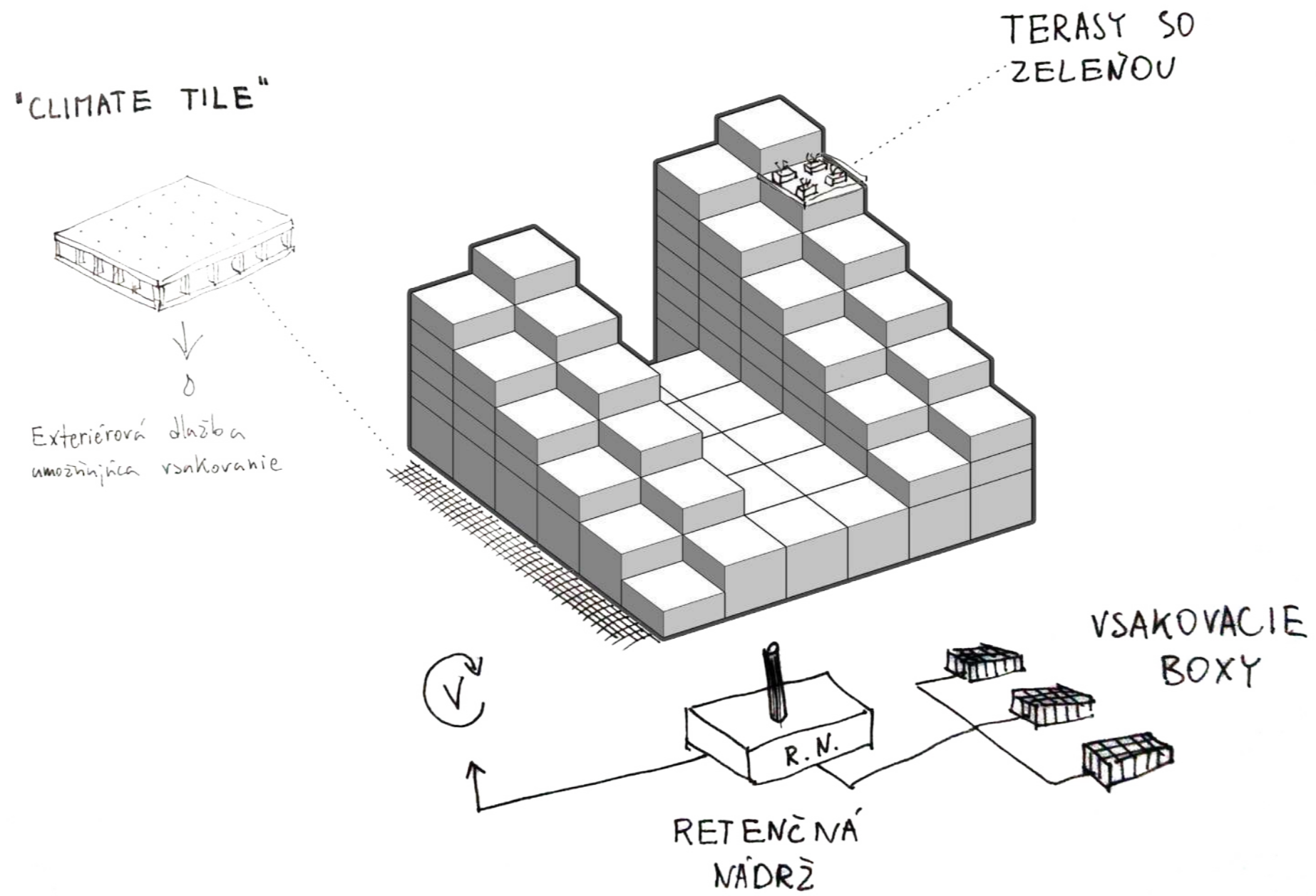

ĎAKUJEM ZA POZORNOST